



# 490E75=0\_C

**EN** Instructions for use (user) .....



# Table of contents

EN

<b>1</b>	<b>Foreword</b> .....	<b>7</b>
<b>2</b>	<b>Product description</b> .....	<b>7</b>
2.1	Function .....	7
2.2	Product overview .....	8
<b>3</b>	<b>Intended use</b> .....	<b>11</b>
3.1	Indications for use .....	11
3.2	Indications .....	11
3.3	Contraindications .....	11
3.3.1	Absolute Contraindications .....	11
3.3.2	Relative Contraindications .....	11
<b>4</b>	<b>Safety</b> .....	<b>12</b>
4.1	Explanation of warning symbols .....	12
4.2	General safety instructions .....	12
4.3	Side effects .....	13
4.4	Interference due to electromagnetic fields .....	13
4.5	Further information .....	13
4.6	Nameplate and warning labels .....	13
4.6.1	Signage on the product .....	13
4.6.2	Nameplate .....	15
4.6.3	Warning labels .....	16
<b>5</b>	<b>Delivery</b> .....	<b>17</b>
5.1	Scope of delivery .....	17
5.2	Accessories .....	17
5.2.1	Accessories from other manufacturers .....	18
5.3	Storage .....	18
5.3.1	Storage during daily use .....	18
5.3.2	Storage during extended disuse .....	18
<b>6</b>	<b>Preparing the product for use</b> .....	<b>19</b>
6.1	Safety instructions .....	19
6.2	Initial operation .....	19
6.3	Settings .....	19
6.3.1	Adjusting the control device .....	19
<b>7</b>	<b>Use</b> .....	<b>20</b>
7.1	Circuit breaker .....	20
7.2	Side panels .....	20
7.2.1	Removing/installing the side panels .....	20
7.2.2	Elevating the side panels .....	21
7.2.3	Adjusting the side panels .....	22
7.2.4	Adjusting the control panel position .....	22
7.3	Legrests .....	23
7.3.1	Removing/installing the leg supports .....	23
7.3.2	Adjusting the leg supports .....	24
7.4	Backrest .....	26
7.4.1	Folding the back support up/down .....	26
7.4.2	Adjusting the back support angle .....	27
7.5	Getting in and transferring .....	28
7.6	Control unit .....	29
7.6.1	VR2 control unit .....	29
7.6.1.1	Control panel .....	29
7.6.1.1.1	Buttons and display functions .....	30
7.6.1.2	Control panel .....	31
7.6.1.2.1	Buttons and display functions .....	31
7.6.2	R-Net control device with JSM-LED-L control panel .....	33
7.6.2.1	Control panel .....	33

7.6.2.2	Buttons and display functions .....	33
7.6.2.3	Adjustment possibilities .....	35
7.6.3	R-Net control device with TEN° control panel/TEN° LCD module.....	35
7.6.3.1	TEN° control panel .....	35
7.6.3.1.1	Push-button functions .....	36
7.6.3.2	TEN° LCD module .....	37
7.6.3.2.1	Push-button functions .....	38
7.6.3.3	Display functions.....	38
7.6.3.4	Adjustment possibilities .....	44
7.6.3.5	Environmental control via Bluetooth .....	45
7.6.3.5.1	Activating devices .....	45
7.6.3.5.2	Pairing.....	46
7.6.3.5.3	Selecting the connected devices.....	49
7.6.3.5.4	Deactivating devices.....	49
7.6.3.5.5	Operating mouse functions on a PC.....	49
7.6.3.5.6	Operating iOS device functions .....	50
7.6.3.5.7	Operating Android device functions .....	50
7.6.3.6	Environmental control via infrared (IR) .....	50
7.6.3.6.1	Operating IR devices.....	50
7.6.3.6.2	Learning and assigning IR codes .....	51
7.6.3.6.3	Activating and deactivating IR codes .....	52
7.7	Driving functions .....	53
7.7.1	Safety instructions.....	53
7.7.2	Driving notes .....	54
7.7.3	Switching on and off.....	56
7.7.4	Selecting the speed levels.....	57
7.7.5	Driving.....	58
7.7.6	Range.....	58
7.7.7	Anti-tipper .....	59
7.7.8	Drive-away lock.....	59
7.7.8.1	VR2 control unit .....	59
7.7.8.2	R-Net control unit.....	60
7.7.9	Adapting the driving characteristics.....	61
7.8	Enabling/disabling the brakes.....	61
7.9	Batteries/charging process .....	64
7.9.1	Safety instructions.....	64
7.9.2	General .....	64
7.9.3	Battery charging information.....	64
7.9.4	Battery charger .....	65
7.9.5	Charging the batteries .....	65
7.10	Seat .....	68
7.10.1	Safety instructions.....	68
7.10.2	Seat type .....	68
7.10.3	Contoured pads.....	69
7.10.3.1	Detaching/attaching the covers.....	69
7.10.3.2	Cleaning the covers .....	70
7.10.4	Back upholstery .....	70
7.10.5	ADI back support (Baxx line) .....	70
7.10.6	Seat cushion .....	71
7.10.7	Recaro® seat .....	71
7.10.7.1	Settings .....	71
7.10.7.2	Use .....	72
7.10.8	Mounting kit for head/neckrests .....	73
7.10.9	Headrest.....	73
7.11	Power seat functions .....	73
7.11.1	Safety instructions.....	73
7.11.2	Speed reduction .....	74
7.11.3	Power seat height adjustment .....	74
7.11.4	Power seat tilt.....	75

7.11.5	Combined seat height adjustment/seat tilt .....	76
7.11.6	Power back angle adjustment .....	76
7.11.7	Power legrests .....	77
7.11.8	Controlling power seat functions .....	79
7.11.8.1	VR2 control unit .....	79
7.11.8.2	R-Net control unit .....	79
7.11.9	Joystick functions .....	80
7.12	Manual seat functions .....	82
7.12.1	Safety instructions .....	82
7.12.2	Manually elevating legrests .....	82
7.13	Lap belt .....	82
7.13.1	Adaptation .....	83
7.13.2	Use .....	84
7.14	Lap belt with rewinder .....	85
7.14.1	Adaptation .....	85
7.14.2	Use .....	85
7.15	Control unit accessories .....	87
7.15.1	Attendant control .....	87
7.15.1.1	VR2 attendant control .....	87
7.15.1.2	R-Net attendant control .....	88
7.15.2	Joystick top .....	90
7.15.3	Push-button module .....	90
7.15.4	Memory function .....	91
7.15.5	Centre tray control .....	92
7.15.5.1	Safety instructions .....	92
7.15.5.2	General .....	92
7.15.5.3	Using the product .....	92
7.15.5.4	Cleaning .....	94
7.15.5.5	Maintenance .....	94
7.15.6	TEN° tray module .....	95
7.16	Special controls .....	95
7.16.1	Safety .....	95
7.16.2	General .....	95
7.16.2.1	Switching on .....	95
7.16.2.2	TEN° LCD module .....	95
7.16.3	Joystick controls .....	95
7.16.3.1	Product description .....	96
7.16.3.2	Joystick commands .....	97
7.16.3.3	Drive mode .....	98
7.16.3.4	Latched drive mode .....	98
7.16.3.5	User switch .....	98
7.16.4	Push-button controls .....	99
7.16.4.1	Product description .....	99
7.16.4.2	1-button control (scan function) .....	99
7.16.4.3	3-button control .....	100
7.16.4.4	4-button control .....	101
7.16.5	Sip and puff control .....	101
7.16.5.1	Product description .....	101
7.16.5.2	Sip and puff commands .....	102
7.16.5.3	Drive mode .....	102
7.16.5.4	Cleaning and Care .....	103
7.16.6	Swivel arm .....	103
7.16.6.1	Functions of the satellite switch .....	103
7.16.6.2	Operating the swivel unit .....	103
7.16.7	Wireless environmental control .....	103
7.17	Additional options .....	105
7.17.1	Control panel holder .....	105
7.17.2	Lighting .....	106
7.17.2.1	Lighting for road traffic .....	106

7.17.2.2	Lighting (not intended for road traffic)	106
7.17.3	Belts/belt systems	107
7.17.3.1	Adaptation	107
7.17.3.2	Use	108
7.17.4	Caster wheel swivel lock	109
7.17.5	Spring-mounted caster wheel swing arm	110
7.17.6	Mechanical track stabiliser	110
7.17.7	Mechanical track stabiliser with ASM	111
7.17.8	Electronic track stabiliser	111
7.17.9	Tray	111
7.17.9.1	Safety instructions	111
7.17.9.2	Using the product	112
7.17.9.3	Cleaning	113
7.17.9.4	Maintenance	113
7.17.10	Luggage carrier	113
7.17.11	Curb climbing assist	114
7.17.12	External power supply	114
7.17.13	Hand heater	115
7.17.14	Backpack hook	115
7.17.15	Overview of other options	115
7.18	Disassembly and transport	116
7.18.1	Safety instructions	116
7.18.2	Reducing the transportation size	116
7.18.3	Preparing for transport	117
7.19	Use in vehicles for transporting persons with reduced mobility	118
7.19.4	Prohibited use	122
7.20	Care	122
7.20.1	Safety instructions	122
7.20.2	Cleaning	122
7.20.3	Disinfection	123
<b>8</b>	<b>Maintenance and repair</b>	<b>123</b>
8.1	Maintenance	123
8.1.1	Maintenance intervals	123
8.2	Repair	125
8.2.1	Replacing defective lights	125
8.2.2	Replacing the battery	125
8.3	Troubleshooting	125
8.3.1	Types of notifications	125
8.3.2	Procedure for warnings and error messages	126
8.3.3	Wheelchair control unit error overview	126
8.3.4	Attendant control error overview	131
8.4	Behaviour in case of breakdowns	132
<b>9</b>	<b>Disposal</b>	<b>132</b>
9.1	Safety instructions	132
9.2	Disposal information	132
<b>10</b>	<b>Legal information</b>	<b>133</b>
10.1	Liability	133
10.2	Warranty	133
10.3	Privacy notice	133
10.4	Lifetime	133
<b>11</b>	<b>Technical data</b>	<b>133</b>
<b>12</b>	<b>Appendices</b>	<b>143</b>
12.1	Threshold values for wheelchairs transportable by train	143
12.2	Sound emission information	143

# 1 Foreword

## INFORMATION

Date of last update: 2021-02-15

- ▶ Please read this document carefully before using the product and observe the safety notices.
- ▶ Obtain instruction from the qualified personnel in the safe use of the product.
- ▶ Please contact the qualified personnel if you have questions about the product or in case of problems.
- ▶ Report each serious incident related to the product to the manufacturer and to the relevant authority in your country. This is particularly important when there is a decline in the health state.
- ▶ Please keep this document for your records.

## INFORMATION

- ▶ New information regarding product safety and product recalls as well as the declaration of conformity can be obtained at [ccc@ottobock.com](mailto:ccc@ottobock.com) or from the manufacturer's service department (see inside or outside of back cover for addresses).
- ▶ You can request this document as a PDF file at [ccc@ottobock.com](mailto:ccc@ottobock.com) or from the manufacturer's service department (see inside or outside of back cover for addresses). The PDF file can also be displayed in a larger size.

- The product was adapted to the needs of the user. Subsequent changes may be made only by qualified personnel. We recommend checking the product settings **once per year** to ensure optimal treatment over the long term. Especially for users with a changing anatomy (for example body dimensions, weight), an adjustment at least **once every six months** is recommended.

You have received a product that is very versatile for everyday use at home and outdoors.

In order to exclude injuries of any type, familiarise yourself with the handling, functions and intended use of the product before using it. These instructions for use provide you with the related necessary information.

### Please note the following in particular:

- All users and/or their attendants must be trained by qualified personnel in the use of the product. In particular, users and/or attendants must be informed of the residual risks with the aid of the safety notices in the instructions for use (user).
- Note the address and telephone number of the responsible qualified personnel and keep this information with you, especially when using the product outdoors. Inform the qualified personnel immediately in case of a malfunction. Provide all relevant details to make quick assistance possible.
- Your product may differ from the models shown.
- The manufacturer reserves the right to make technical changes to the model described in these instructions for use.

## 2 Product description

### 2.1 Function

The wheelchair is intended exclusively for transporting one person on the seat.

The wheelchair can be used indoors on solid surfaces (Category A according to EN 12184).

The wheelchair can be used indoors and outdoors on solid surfaces (Category B according to EN 12184).

The power wheelchair is equipped with rear-wheel drive for good directional stability and to enable a small turning radius.

The drive system with two 12 V batteries combined with spring-mounted drive wheels allows obstacles to be crossed easily and offers safe operating performance.

The power wheelchair is equipped with front-wheel drive for excellent directional stability.

The drive system with two 12 V batteries combined with spring-mounted drive wheels allows obstacles to be crossed easily and offers safe operating performance.

The power wheelchair is equipped with mid-wheel drive for good directional stability and to enable a very small turning radius.

The drive system with two 12 V batteries combined with spring-mounted drive wheels allows obstacles to be crossed easily and offers safe operating performance.

The power wheelchair is controlled by the VR2 wheelchair control device (see page 29). The latter includes a control panel to enter driving commands and display the current status as well as a controller that operates the drive motors and other electrical functions based on the inputs.

The power wheelchair is controlled by the R-Net wheelchair control device (see page 29). The corresponding control panel serves to enter driving commands and display the current status. The control electronics in the controller make it possible to control the drive motors and other power functions based on the input data.

The special features of the power wheelchair include:

- Individual adaptation possibilities for control device using programming and options.
- Individual adaptation possibilities with options and custom fabrication using modular components (chassis, seating system, control device, accessories).
- Modular design that allows the power wheelchair to be equipped with additional modules and installed equipment in addition to the main components, such as power seat adjustments, special controls, tray.
- Serviceability due to easy, straightforward access to all components.

## 2.2 Product overview

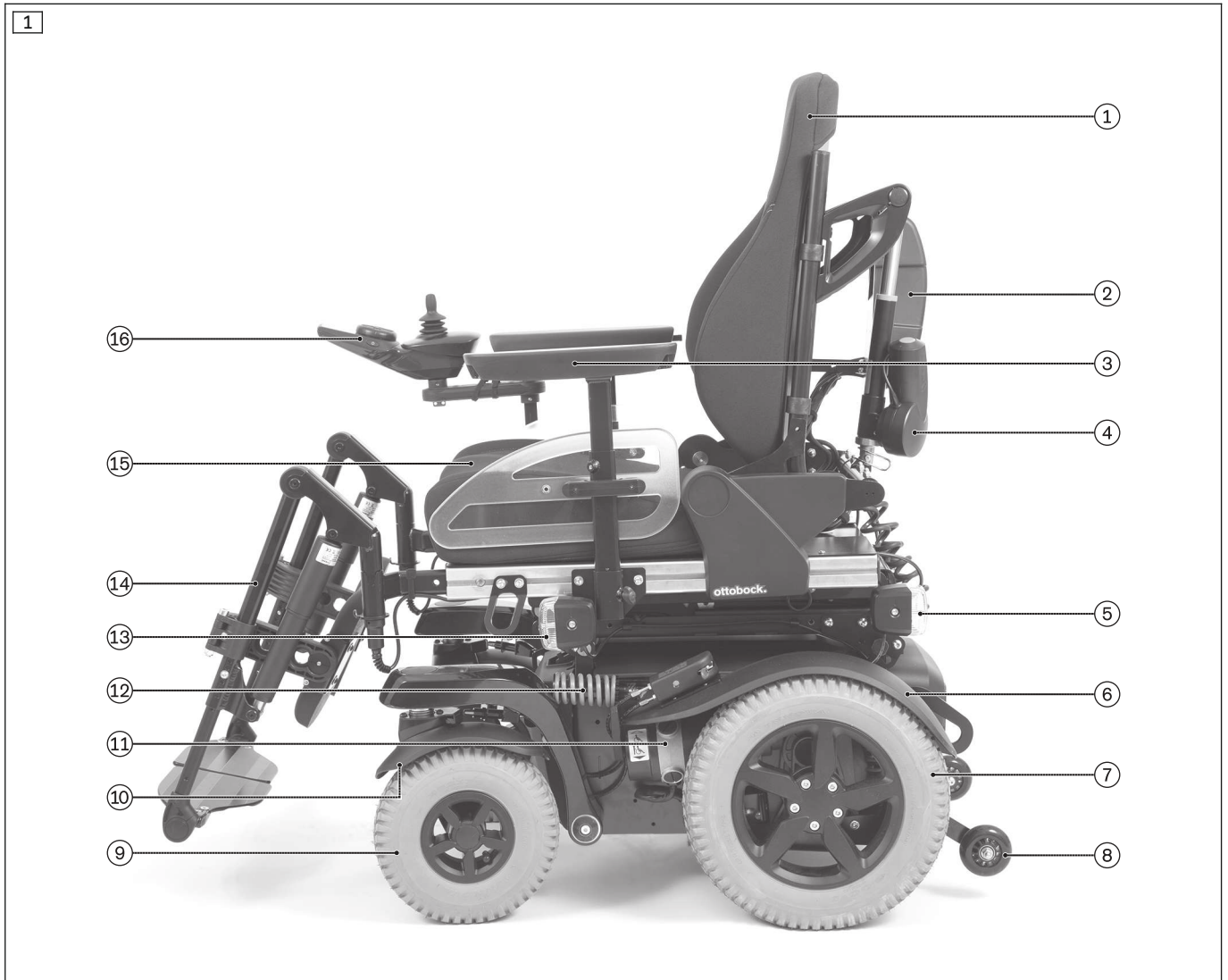

- |   |  |    |                           |
|---|--|----|---------------------------|
| 1 | Back support                                     | 9  | Caster wheel              |
| 2 | Module carrier for control electronics           | 10 | Caster wheel splash guard |
| 3 | Side panel with arm support                      | 11 | Motor with brake release  |
| 4 | Back support angle adjustment (power adjustment) | 12 | Suspension                |
| 5 | Rear lights                                      | 13 | Front light               |
| 6 | Drive wheel splash guard                         | 14 | Leg support               |
| 7 | Drive wheel                                      | 15 | Seat cushion              |
| 8 | Anti-tipper                                      | 16 | Control panel             |



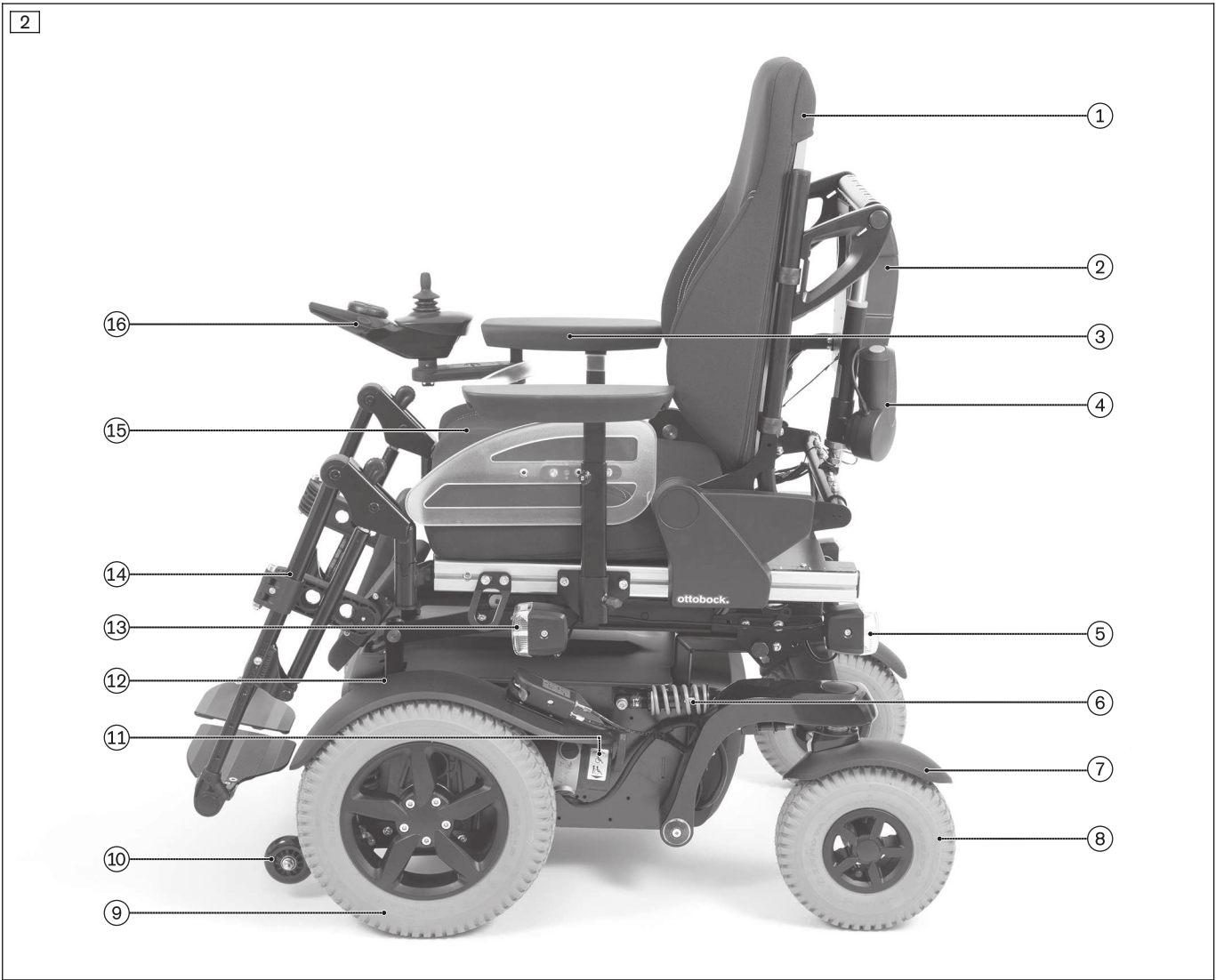

- |   |  |    |                          |
|---|--|----|--------------------------|
| 1 | Back support                                     | 9  | Drive wheel              |
| 2 | Module carrier for control electronics           | 10 | Anti-tipper              |
| 3 | Side panel with arm support                      | 11 | Motor with brake release |
| 4 | Back support angle adjustment (power adjustment) | 12 | Drive wheel splash guard |
| 5 | Rear lights                                      | 13 | Front light              |
| 6 | Suspension                                       | 14 | Leg support              |
| 7 | Caster wheel splash guard                        | 15 | Seat cushion             |
| 8 | Caster wheel                                     | 16 | Control panel            |

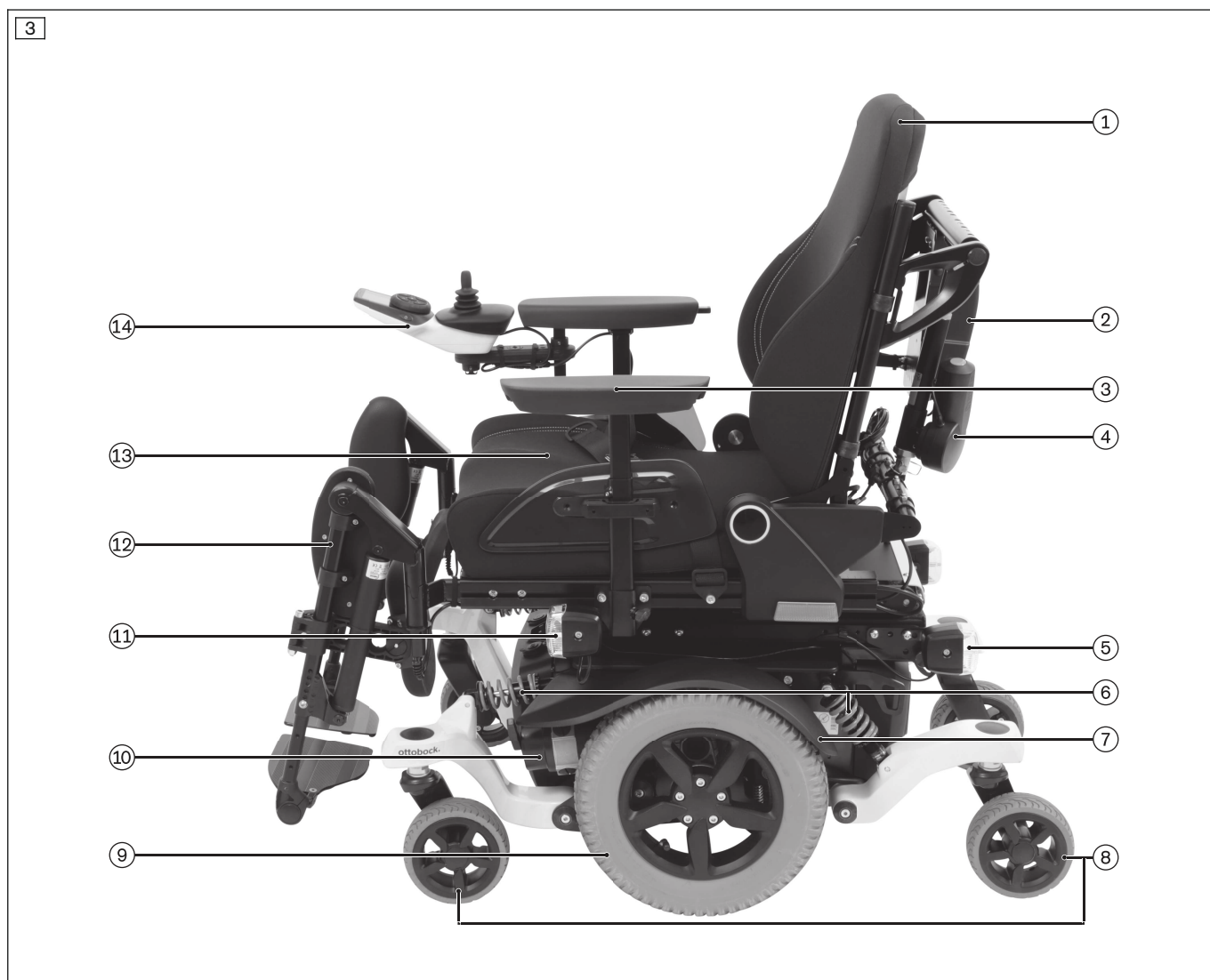

- |   |  |    |                          |
|---|--|----|--------------------------|
| 1 | Back support                                     | 8  | Caster wheels            |
| 2 | Module carrier for control electronics           | 9  | Drive wheel              |
| 3 | Side panel with arm support                      | 10 | Motor with brake release |
| 4 | Back support angle adjustment (power adjustment) | 11 | Front light              |
| 5 | Rear lights                                      | 12 | Leg support              |
| 6 | Suspension                                       | 13 | Seat cushion             |
| 7 | Drive wheel splash guard                         | 14 | Control panel            |

### 3 Intended use

The safe use of the product can only be ensured in case of intended use in accordance with the information contained in these instructions for use. The user is ultimately responsible for accident-free operation.

#### 3.1 Indications for use

The wheelchair is intended for indoor transportation, by the user, of people with temporary or permanent limitations of the ability to walk, inability to walk or difficulty standing up. Optionally, the power wheelchair can be controlled by an attendant with the help of an attendant control device.

The product is suitable for users with intact skin whose anatomy (such as body dimensions and weight) permits the intended use of the product.

The wheelchair may only be used with the options listed on the order form.

The manufacturer assumes no liability for combinations with third-party medical devices and/or accessories not included in the modular system.

The wheelchair is intended for indoor and outdoor transportation, by the user or an attendant, of people with temporary or permanent limitations of the ability to walk, inability to walk or difficulty standing up. Optionally, the power wheelchair can be controlled by an attendant with the help of an attendant control device.

The product is suitable for users with intact skin whose anatomy (such as body dimensions and weight) permits the intended use of the product.

The wheelchair may only be used with the options listed on the order form.

The manufacturer assumes no liability for combinations with third-party medical devices and/or accessories not included in the modular system.

#### 3.2 Indications

- Minor to pronounced or complete restrictions of mobility

#### 3.3 Contraindications

##### 3.3.1 Absolute Contraindications



- None known

##### 3.3.2 Relative Contraindications

- Failure to meet physical or mental requirements

## 4 Safety

### 4.1 Explanation of warning symbols

 <b>WARNING</b>	Warning regarding possible serious risks of accident or injury.
 <b>CAUTION</b>	Warning regarding possible risks of accident or injury.
 <b>NOTICE</b>	Warning regarding possible technical damage.

### 4.2 General safety instructions

#### Hazards due to improper use of the product

 **WARNING**

**Improper product operation**  
 Falling, tipping over, collision due to user error

- ▶ The product may only be used by a qualified user.
- ▶ As a user or attendant, you must be trained in the use of the product by qualified personnel.
- ▶ Read the entire instructions for use.
- ▶ The product may not be used in case of exhaustion or under the influence of alcohol, medications or drugs.
- ▶ The product may **not** be used by users who have any cognitive limitations that can temporarily or permanently limit attentiveness and judgement. Physical limitations (such as poor eyesight) may temporarily or permanently exclude use of the product as well.
- ▶ Observe road traffic regulations during operation in public road traffic.

 **WARNING**

**Impermissible use**  
 Risk of pinching, crushing, being pulled in, tipping, falling due to improper handling

- ▶ Only use this product for its original intended purpose.
- ▶ Only one person may be transported with the product at any one time.

 **WARNING**

**Overloading**  
 Severe injuries if the product tips over due to overloading, damage to the product

- ▶ Do not exceed the maximum load capacity (see the nameplate and section "Technical data").
- ▶ Please note that certain accessories and add-on components will reduce the remaining load capacity.

 **WARNING**

**Exceeding the service life**  
 Serious injuries due to failure to observe the manufacturer's requirements

- ▶ Using the product beyond the specified expected service life leads to increased residual risk.
- ▶ Observe the specified service life.

 **CAUTION**

**Skin damage**  
 Skin damage or pressure points due to overloading

- ▶ Check your skin for intactness before and during use of the product.
- ▶ Pay attention to diligent skin care and pressure redistribution during interruptions in using the product.
- ▶ If skin damage or other problems occur during use, stop using the product. Consult the qualified personnel.

 **CAUTION**

**Use of the product during diagnostic examinations and therapeutic treatment**  
 Impairment of the examination results or the effectiveness of treatment due to interactions of the product with devices that are used

- ▶ Make sure that examinations and treatments are carried out exclusively under the prescribed conditions.

**⚠ CAUTION****Extreme temperatures**

Hypothermia or burns due to contact with components, failure of components

- ▶ Do not expose the product to any extreme temperatures (e.g. direct sunlight, sauna, extreme cold).
- ▶ Do not leave the product in the immediate vicinity of heaters.

**NOTICE****Use under incorrect environmental conditions**

Damage to the product due to excessively high or low temperatures

- ▶ Only use the product within a temperature range of **-15 °C to +40 °C (5 °F to +104 °F)**.

**Danger due to neglect of duty to supervise****⚠ WARNING****Neglecting the duty to supervise**

Risk of suffocation due to small loose parts

- ▶ Note that the product includes small parts that can be loosened and removed without tools.
- ▶ Ensure that small children, for example, do not swallow them.

**4.3 Side effects**

The following side effects may occur during use of the product:

- Neck, muscle and joint pain
- Circulatory disorders, risk of pressure sores

Contact a doctor or therapist in case of problems.

**4.4 Interference due to electromagnetic fields****⚠ CAUTION****Electromagnetic fields of other electrical equipment**

Falling, collision with persons or objects due to interference with the power wheelchair's control signals

- ▶ The power wheelchair complies with all applicable EMC directives and standards and has been tested accordingly.
- ▶ Nevertheless, interference with the product's control device by other electronic equipment may be possible under certain circumstances (e.g. radio and television stations, amateur radio transmitters (HAM), two-way radios, medical equipment that emits radiation or also mobile phones). This can influence the functions of the control device and lead to unwanted deviations of the driving characteristics.
- ▶ In this case, move the product out of range of the interference source or turn the interference source off. If this is not possible, turn the product's control device off and inform the qualified personnel.
- ▶ Interference due to other portable electrical devices is more unlikely (e.g. cordless telephones, laptops, tablets, networked wristwatches, radios, electric shavers or electric toothbrushes).

**INFORMATION**

- ▶ Interference with other devices in the vicinity (e.g. alarm systems in department stores or automatic doors) by the product's own electromagnetic fields cannot be excluded.
- ▶ In this case, move your product out of interference range or turn off the power wheelchair's control device.

**4.5 Further information****INFORMATION**

The serial number required for enquiries and ordering spare parts and accessories is found on the nameplate. For explanations of the nameplate, see the section "Nameplate" (see page 15).

**4.6 Nameplate and warning labels****4.6.1 Signage on the product**

The warning signs and nameplates are attached at the following mounting points to the power wheelchair:

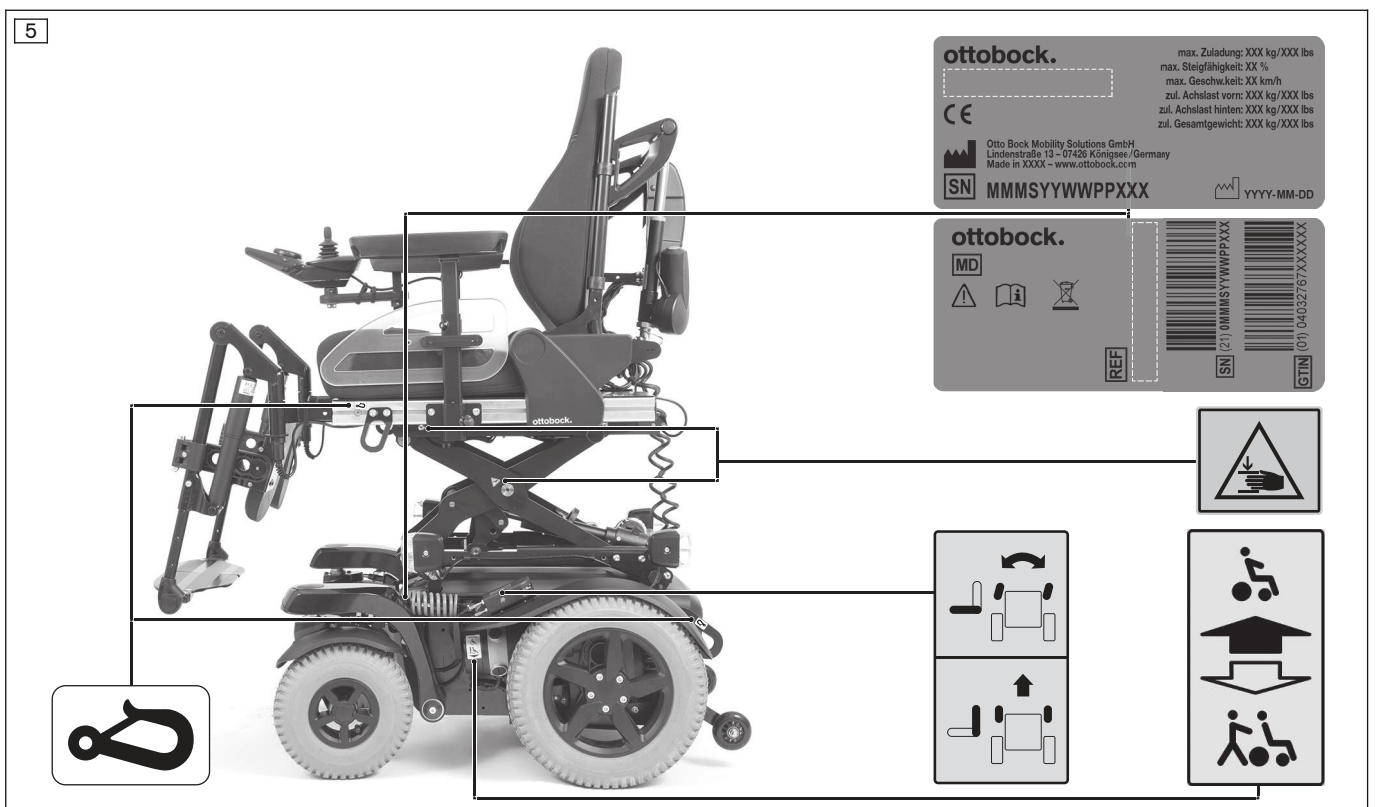
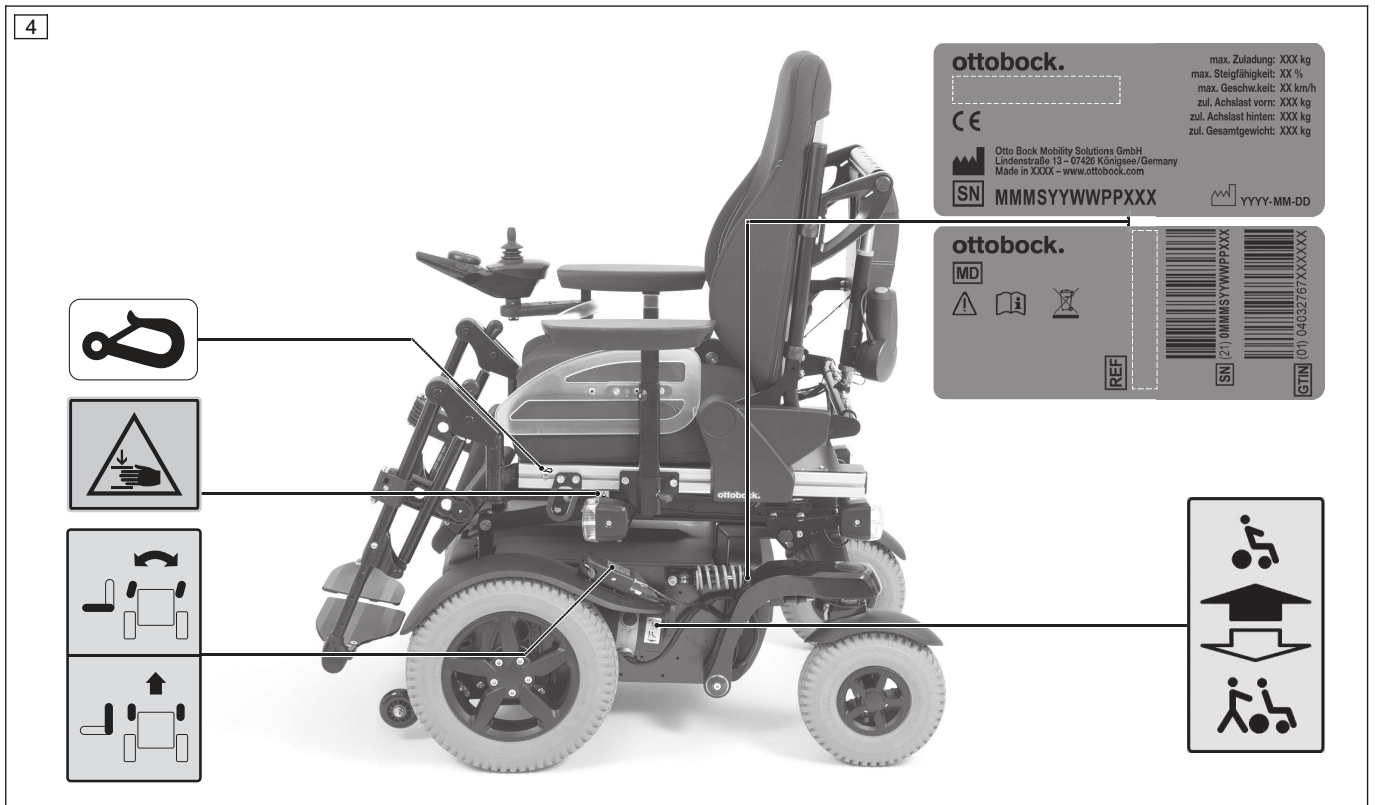

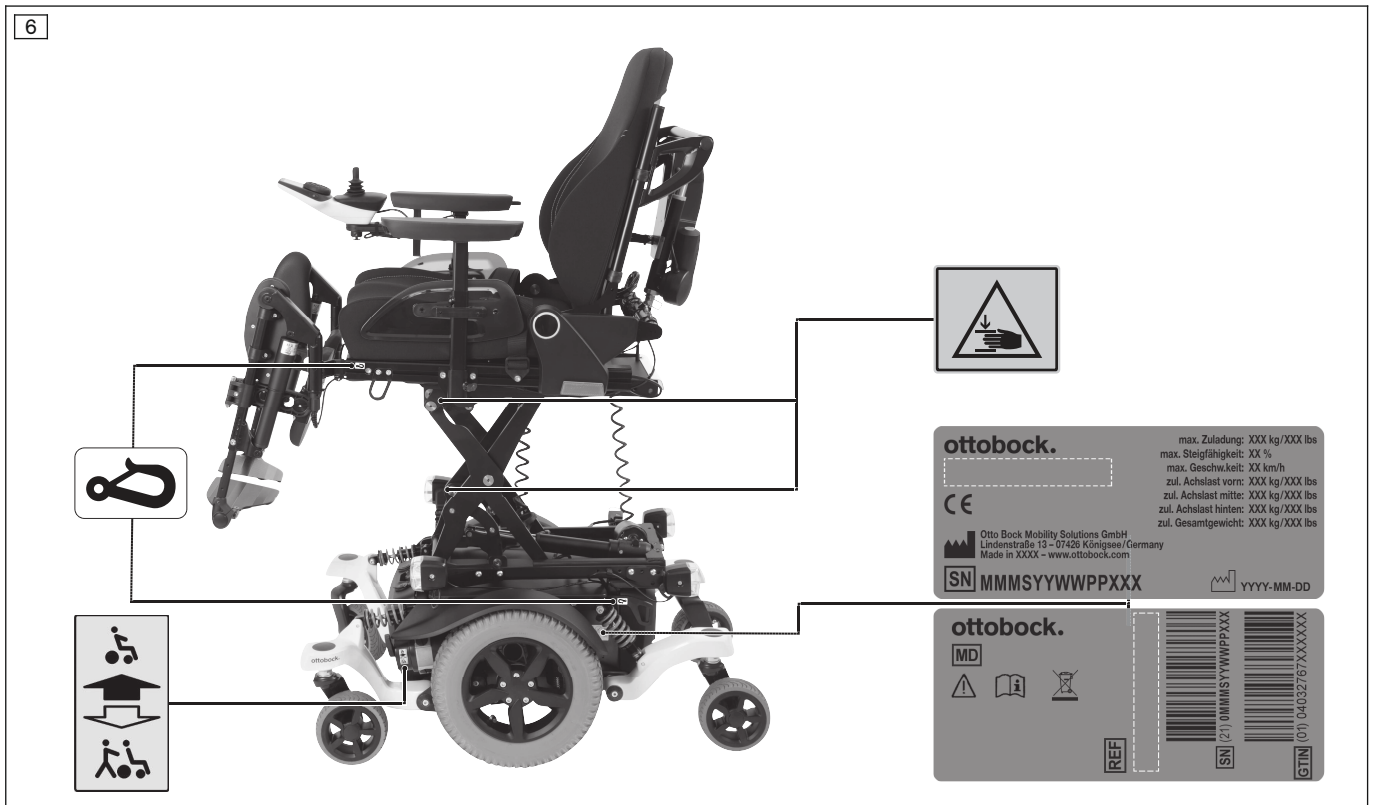

### 4.6.2 Nameplate

The nameplates are found on the mobility base.

Label	Meaning
<b>ottobock.</b>	<b>A</b> Manufacturer's product name
<b>CE</b>	<b>B</b> CE marking
<b>C</b> max. Zuladung: XXX kg/XXX lb	<b>C</b> Maximum load (see section "Technical data")
<b>D</b> max. Steigfähigkeit: X%/XX %	<b>D</b> Maximum climbing ability (see section "Technical data")
<b>E</b> max. Geschw.keit: XX km/h	<b>E</b> Maximum speed (see section "Technical data")
<b>F</b> zul. Achslast vorn: XXX kg/XXX lb	<b>F</b> Allowable axle load, front
<b>G</b> zul. Achslast hinten: XXX kg/XXX lb	<b>G</b> Allowable axle load, rear
<b>H</b> zul. Gesamtgewicht: XXX kg/XXX lb	<b>H</b> Allowable overall weight
<b>I</b> Otto Bock Mobility Solutions GmbH Lindenstraße 13 – 07426 Königsee/Germany Made in XXXX – www.ottobock.com	<b>I</b> Manufacturer information/address
<b>J</b> SN MMMSYYWWPPXXX	<b>J</b> Serial number <sup>1)</sup>
<b>K</b> YYY-MM-DD	<b>K</b> Manufacturing date <sup>2)</sup>
<b>L</b> MD	<b>L</b> Symbol for medical device
<b>M</b>	<b>M</b> <b>WARNING!</b> Read the instructions for use before using the product. Observe important safety-related information (e.g. warnings, precautions).
<b>N</b>	<b>N</b> Symbol for separate collection of electrical and electronic devices. Components of the power wheelchair and batteries may not be disposed of in household waste.
<b>O</b> REF	<b>O</b> Manufacturer's reference number for the product variant
<b>P</b> SN (21) 0MMMSYYWWPPXXX	<b>P</b> Serial number (PI) <sup>3),1)</sup>
<b>Q</b> GTIN (01) 04032767XXXXXX	<b>Q</b> Global Trade Item Number (DI) <sup>4)</sup>

1) MMM = model/model variant; S = speed code; YY = year of manufacture; WW = week of manufacture; PP = production site; XXX = sequential production number

2) YYY-MM-DD = year of manufacture; MM = month of manufacture; DD = day of manufacture

3) UDI-PI to GS1 standard; UDI = Unique Device Identifier, PI = Product Identifier

4) UDI-DI to GS1 standard; UDI = Unique Device Identifier, DI = Device Identifier

Label	Meaning
	<b>A</b> Manufacturer's product name
	<b>B</b> CE marking
	<b>C</b> Maximum load (see section "Technical data")
	<b>D</b> Maximum climbing ability (see section "Technical data")
	<b>E</b> Maximum speed (see section "Technical data")
	<b>F</b> Allowable axle load, front
	<b>G</b> Allowable axle load, middle
	<b>H</b> Allowable axle load, rear
	<b>I</b> Allowable overall weight
	<b>J</b> Manufacturer information/address
	<b>K</b> Serial number <sup>1)</sup>
	<b>L</b> Manufacturing date <sup>2)</sup>
	<b>M</b> Symbol for medical device
	<b>N</b> <b>WARNING!</b> Read the instructions for use before using the product. Observe important safety-related information (e.g. warnings, precautions).
	<b>O</b> Symbol for separate collection of electrical and electronic devices. Components of the power wheelchair and batteries may not be disposed of in household waste.
	<b>P</b> Manufacturer's reference number for the product variant
<b>Q</b> Serial number (PI) <sup>3),1)</sup>	
<b>R</b> Global Trade Item Number (DI) <sup>4)</sup>	

- 1) MMM = model/model variant; S = speed code; YY = year of manufacture; WW = week of manufacture; PP = production site; XXX = sequential production number
- 2) YYYY = year of manufacture; MM = month of manufacture; DD = day of manufacture
- 3) UDI-PI to GS1 standard; UDI = Unique Device Identifier, PI = Product Identifier
- 4) UDI-DI to GS1 standard; UDI = Unique Device Identifier, DI = Device Identifier



	<p>If the adjacent symbol appears on the nameplate, this indicates the following: The product may <b>not</b> be used as a seat in vehicles for transporting persons with reduced mobility.</p>
--	--



Rótulo/etiqueta	Significado
	<b>A</b> <b>ADVERTÊNCIA!</b> Leia as instruções de utilização antes de usar o produto. Observe as indicações de segurança importantes (por ex., avisos, precauções).
	<b>B</b> Nome do produto do fabricante
	<b>C</b> Número do registro ANVISA (Agência Nacional de Vigilância Sanitária)
	<b>D</b> Número do CNPJ (Cadastro Nacional da Pessoa Jurídica)
	<b>E</b> Dados do fabricante/endereço

### 4.6.3 Warning labels

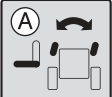
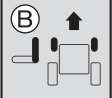
Label	Meaning
	<b>A</b> Power driving mode: motor brake locked (see page 61)
	<b>B</b> Manual driving mode: motor brake released (see page 61)



Label	Meaning
 	<b>A</b> Caster wheel swivel lock: the caster wheels are unlocked and can swivel freely (when ordered) <b>B</b> Caster wheel swivel lock: the caster wheels are locked for driving straight ahead (when ordered)
	Risk of pinching. Do not reach into the danger area.

Label	Meaning
	<b>A</b> Power driving mode: motor brake locked (see page 61) <b>B</b> Manual driving mode: motor brake released (see page 61)
	Risk of pinching. Do not reach into the danger area.

Label	Meaning																					
 <table border="1" data-bbox="300 1032 555 1144"> <tr> <td>CS: Třída A</td> <td>HR: Razred A</td> <td>RU: Knacc A</td> </tr> <tr> <td>DA: Klasse A</td> <td>HU: Osztály A</td> <td>SK: Trieda A</td> </tr> <tr> <td>DE: Klasse A</td> <td>IT: Classe A</td> <td>SL: Razred A</td> </tr> <tr> <td>EN: Class A</td> <td>NL: Klasse A</td> <td>SV: Klass A</td> </tr> <tr> <td>ES: Categoría A</td> <td>NO: Klasse A</td> <td>TR: Sınıf A</td> </tr> <tr> <td>FI: Luokka A</td> <td>PL: Klasa A</td> <td></td> </tr> <tr> <td>FR: Classe A</td> <td>PT: Classe A</td> <td></td> </tr> </table>	CS: Třída A	HR: Razred A	RU: Knacc A	DA: Klasse A	HU: Osztály A	SK: Trieda A	DE: Klasse A	IT: Classe A	SL: Razred A	EN: Class A	NL: Klasse A	SV: Klass A	ES: Categoría A	NO: Klasse A	TR: Sınıf A	FI: Luokka A	PL: Klasa A		FR: Classe A	PT: Classe A		Only for application class A (category A according to DIN EN 12184)
CS: Třída A	HR: Razred A	RU: Knacc A																				
DA: Klasse A	HU: Osztály A	SK: Trieda A																				
DE: Klasse A	IT: Classe A	SL: Razred A																				
EN: Class A	NL: Klasse A	SV: Klass A																				
ES: Categoría A	NO: Klasse A	TR: Sınıf A																				
FI: Luokka A	PL: Klasa A																					
FR: Classe A	PT: Classe A																					

Label	Meaning
	<b>(Only in case of installation of ISO sets according to ISO 7176-19)</b> Fixation point/eyebolt to attach the product in vehicles for transporting persons with reduced mobility

## 5 Delivery

### 5.1 Scope of delivery

The power wheelchair is normally shipped fully assembled and fitted to the personal requirements of the respective user.

The scope of delivery includes:

- Fitted power wheelchair with main components
- Options depending on equipment
- Battery charger
- Instructions for use (user)
- Instructions for use for accessories (depending on equipment)

### 5.2 Accessories

The standard model can be fitted to the user's personal requirements thanks to a large range of options.

A full list of the available modules and accessories is shown on the order form and in the accessories catalogue.

For use of the options, see the section "Use".

Please note that retrofitting options further reduces the maximum load capacity (user weight + luggage).

The maximum load capacity (see print on the nameplate; see page 15) is thereby respectively reduced by the weight of the retrofitted options.

### 5.2.1 Accessories from other manufacturers

As per the order for the power wheelchair, some components from third-party manufacturers have been installed prior to delivery. Please observe the following instructions in this regard:

- Accessories from other manufacturers must be intended for use on wheelchairs and must fulfil all currently applicable legal requirements.
- When using the accessories from other manufacturers, the instructions for use / manufacturer's instructions for the relevant accessories must be strictly observed. These are included with the instructions for use.
- Ottobock assumes no liability for combinations with medical devices and/or accessories from other manufacturers outside the Ottobock modular system.
- In case of questions or problems with accessories from other manufacturers, please contact the qualified personnel who adjusted this product.

## 5.3 Storage

### 5.3.1 Storage during daily use

The power wheelchair should always be protected against external influences.

The control unit must be turned off.

### 5.3.2 Storage during extended disuse

#### NOTICE

##### Deep discharge

Battery damage due to standby current

- ▶ Deactivate the circuit breaker if the wheelchair is not used for more than 3 days.
- ▶ To deactivate the circuit breaker: see page 20

Please observe the following if the power wheelchair is not used for more than **3 days**:

#### Storage conditions

- Store the power wheelchair in a dry, enclosed room with sufficient air circulation and protection from external influences. Specific information about storage conditions: see page 133.
- Protect the wheels against ground frost, for example by taking all weight off them using an assembly stand or by setting them onto wooden blocks.
- Maintain sufficient clearance from sources of heat. If the product is parked for an extended period of time or the tyres overheat (e.g. in the vicinity of radiators or in case of exposure to strong sunlight behind glass), the tyres may become permanently deformed.
- Fill pneumatic tyres with slight overpressure.
- Rotate the wheels weekly to prevent flat tyres from extended standing.
- For extended storage, store the power wheelchair so the wheels are not in contact with the ground.

#### Note regarding the tyres

- If the power wheelchair is not moved for several days, permanent colour changes may develop where it comes into contact with the ground. A suitable base should therefore be used when parking it for extended periods of time.
- Black tyres contain carbon black particles. They may leave black friction marks where they come into contact with the ground. Therefore, the manufacturer recommends grey tyres if the product is primarily used indoors.
- Avoid unnecessary parking outdoors. Direct exposure to sunlight/UV radiation causes the tyres to age more quickly. As a result, the tread surface hardens and corner pieces break out of the tread.
- The tyres must be changed when the tread is less than **1 mm (0.04")** to ensure safe driving behaviour.
- The tyres should be replaced every **2 years** regardless of wear and tear.
- When power wheelchairs with PU tyres are parked for longer periods, the tyres may become deformed (flat spots). This deformation will go away on its own over time while driving.

## 6 Preparing the product for use

### 6.1 Safety instructions

#### **⚠ WARNING**

##### **Improper handling of packaging materials**

Risk of suffocation due to neglect of the duty to supervise

- ▶ Packaging materials must be kept out of the reach of children.

#### **⚠ WARNING**

##### **Uncontrolled movement of components when making adjustments**

Crushing, pinching, blows due to non-observance of the maintenance and repair instructions

- ▶ Ensure that body parts, such as hands or head, are never in the danger zone.
- ▶ Perform the work with the aid of a helper for support.

#### **⚠ WARNING**

##### **Independent modification of settings**

Serious injuries to the user due to improper changes to the product

- ▶ Do not modify the settings established by the qualified personnel. Only the settings described in the section "Use" in these instructions for use may be adjusted independently.
- ▶ In case of problems with the settings, please contact the qualified personnel who adjusted your product.

#### **⚠ CAUTION**

##### **Screw connections not tightened**

Pinching, crushing, tipping over, falling of user due to assembly errors

- ▶ After all adjusting/readjusting work authorised by the manufacturer, retighten the mounting screws/nuts firmly. Observe any torque settings which may be specified.

### 6.2 Initial operation

The qualified personnel delivers the power wheelchair fully assembled and in operational condition.

The following additional tasks may be required:

- Activating the circuit breaker (see page 20)
- Folding up the backrest (see page 26)
- Charging the battery (see page 65)

### 6.3 Settings

The user or attendant may only perform the fine-tuning adjustments described in the following. The user should be sitting upright in the power wheelchair while making adjustments.

- Adjusting the back angle (see page 27)
- Adjusting the armrests (see page 22)
- Adjusting the position of the control panel (see page 22)
- Adjusting the lower leg length (see page 24)
- Adjusting the lap belt (see page 82)
- Adjusting the belt lengths (see page 107)

Further adjustments may be made only by qualified personnel

All parts of the product should be cleaned thoroughly before adjustments are made.

#### 6.3.1 Adjusting the control device

#### **⚠ WARNING**

##### **Incorrect configuration of the control device**

Falling, tipping over, collision due to incorrect parameter settings

- ▶ The parameter settings of the control device may only be changed by qualified personnel. The manufacturer of the product and the control device manufacturer are not liable in case of damage caused by parameter settings that were incorrectly configured or not adjusted properly according to the user's abilities.

If necessary, the qualified personnel can adapt the preconfigured parameters of the wheelchair control device to the specific requirements of the user.

## 7 Use

### 7.1 Circuit breaker

#### INFORMATION

- ▶ Contact the qualified personnel if the automatic circuit breaker deactivates repeatedly after activation for no discernible reason.
- ▶ If objects are placed on the automatic circuit breaker, movements while driving can trip the circuit breaker, causing the power wheelchair to stop abruptly. Do not place any objects onto the automatic circuit breaker.
- ▶ The automatic circuit breaker should be deactivated for shipping or when the power wheelchair is not being used for an extended period of time.

The automatic circuit breaker has to be activated before the power wheelchair can be switched on. It is located under the seat between the drive wheels.

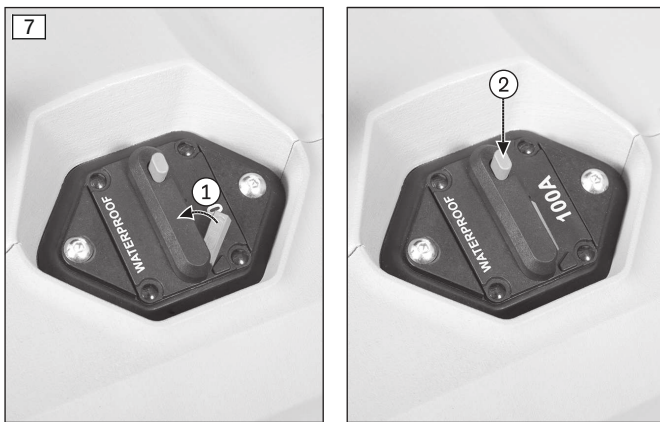

#### Activating the circuit breaker

- ▶ Close the reset lever, which is at an angle (see fig. 7, item 1).
- The reset lever engages and the circuit breaker is activated.

#### Deactivating the circuit breaker

- ▶ Press the pushbutton until the reset lever flips up at an angle (see fig. 7, item 2).
- The circuit breaker is deactivated.

### 7.2 Side panels

The side panels protect the user and his/her clothing from getting dirty. The installed armrests offer the user additional support for the forearms.

#### 7.2.1 Removing/installing the side panels

#### INFORMATION

- ▶ If elevating side panels are mounted on your product, they can be removed in the same manner as described in this section.
- ▶ Follow the instructions for elevating them in the next section.

To make getting in from the side easier or for transportation, the side panels can be removed if needed.

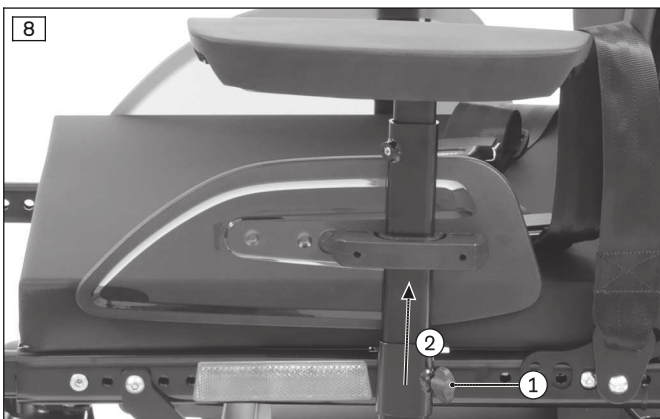

#### Removing the side panel

- 1) Loosen the thumb screw on the side panel holder (see fig. 8, item 1).
- 2) Pull the side panel out from the side panel holder and set it aside (see fig. 8, item 2).
- 3) Only for side panel with control panel:
  - Turn the control device off (see page 29).
  - Carefully let the side panel with the control panel hang down while getting in.
  - For transporting the power wheelchair, place the side panel on the seat.

#### Installing the side panel

- 1) Insert the side panel into the side panel holder.

- 2) Re-tighten the thumb screw on the side panel holder (see fig. 8, item 1).

To make getting in from the side easier or for transportation, the side panels can be removed if needed.

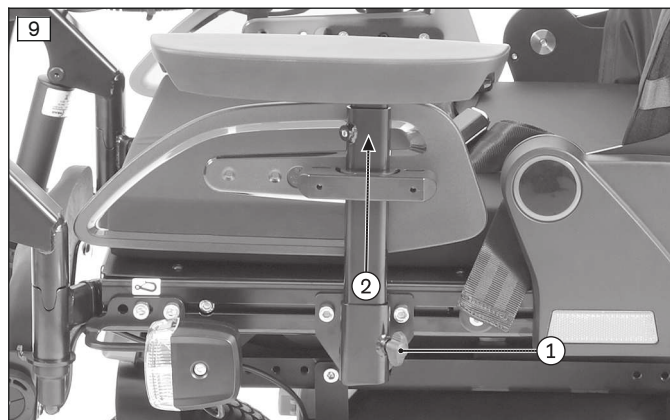

#### Removing the side panel

- 1) Loosen the thumb screw on the side panel holder (see fig. 9, item 1).
- 2) Pull the side panel out from the side panel holder and set it aside (see fig. 9, item 2).
- 3) Only for side panel with control panel:
  - Turn the control unit off (see page 29).
  - Carefully let the side panel with the control panel hang down while getting in.
  - For transporting the power wheelchair, place the side panel on the seat.

#### Installing the side panel

- 1) Insert the side panel into the side panel holder.
- 2) Re-tighten the thumb screw on the side panel holder (see fig. 9, item 1).

To make getting in from the side easier or for transportation, the side panels can be removed if needed.



#### Removing the side panel

- 1) Loosen the thumb screw on the side panel holder (see fig. 10, item 1).
- 2) Pull the side panel out from the side panel holder and set it aside.
- 3) Only for side panel with control panel:
  - Turn the control unit off (see page 29).
  - Carefully let the side panel with the control panel hang down while getting in.
  - For transporting the power wheelchair, place the side panel on the seat.

#### Installing the side panel

- 1) Insert the side panel into the side panel holder.
- 2) Re-tighten the thumb screw on the side panel holder (see fig. 10, item 1).

## 7.2.2 Elevating the side panels

### ⚠ CAUTION

#### Exposed pinch points

Pinching, crushing of limbs due to improper handling

- ▶ Do not reach into the danger area with your fingers when folding up and down the side panels.

### ⚠ CAUTION

#### Impermissible use

Injuries due to abrupt folding, damage to the product

- ▶ Fold up the side panel only for the purpose of getting in and out. Never pull on the side panel when getting in and out. Pay attention to protruding edges.
- ▶ Always put the seat in a horizontal position before folding up or down the side panel.
- ▶ Always switch off the control device before folding up or down the side panel.
- ▶ Note that the side panel is not secured against being folded up and down. The unloaded side panels can fold backwards on their own when the seat is at larger tilt angles.
- ▶ Ensure that both side panels are folded down before you continue using the power wheelchair.

The side panels can be elevated towards the back if necessary to make it easier to get into and out of the wheelchair from the side.

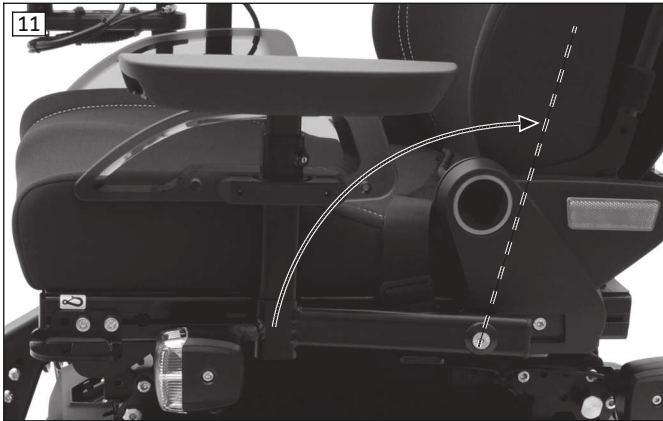

#### Elevating the side panel

- 1) Turn the control device off.
- 2) Grasp the arm support with your hand.
- 3) Swivel up the side panel all the way to the stop (see fig. 11).

#### Moving the side panel back to the front

- 1) Grasp the arm support with your hand.
- 2) Move the side panel back to the front all the way to the stop. Guide the side panel as you do so and do not let it fall down.
- 3) Turn the control device back on.

### 7.2.3 Adjusting the side panels

The height of the armrests, the forearm length and the clothing protector can be subsequently adapted.

The height of the armrests, the forearm length and the depth position of the side panel can be subsequently adapted.



#### Adjusting the armrest height

- 1) Loosen the Allen head screw on the side panel mounting (see fig. 12, item 1).
- 2) Slide the armrests up or down to the desired position.
- 3) Re-tighten the Allen head screw.

#### Adjusting the armrest to the forearm length

- 1) Loosen the 2 Allen head screws on the underside of the armrest (see fig. 12, item 2).
- 2) Push the armrest to the front or back into the desired position.
- 3) Tighten the 2 Allen head screws.

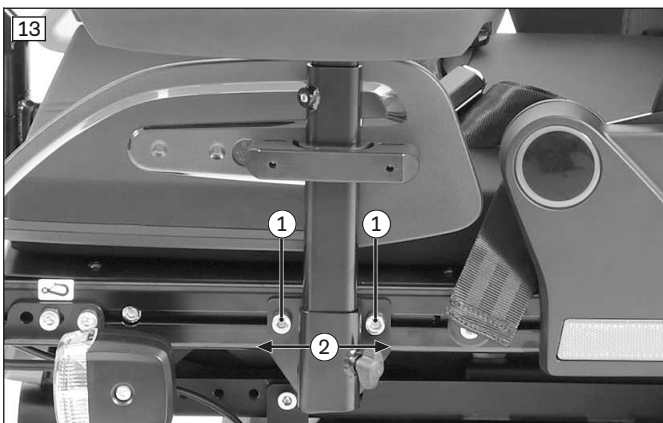

#### Adjusting the side panel depth

- 1) Loosen the 2 Allen head screws on the side panel mounting (see fig. 13, item 1).
- 2) Slide the side panels on the seat profiles as needed (see fig. 13, item 2).
- 3) Firmly re-tighten the 2 Allen head screws to **6 Nm**.

### 7.2.4 Adjusting the control panel position

#### INFORMATION

By default, the control panel is mounted on the side specified in the order. It can also be mounted on the other side of the power wheelchair later on if the user so desires. Please contact the qualified personnel who delivered the product to you.

The depth and height of the control panel position is subsequently adjustable.

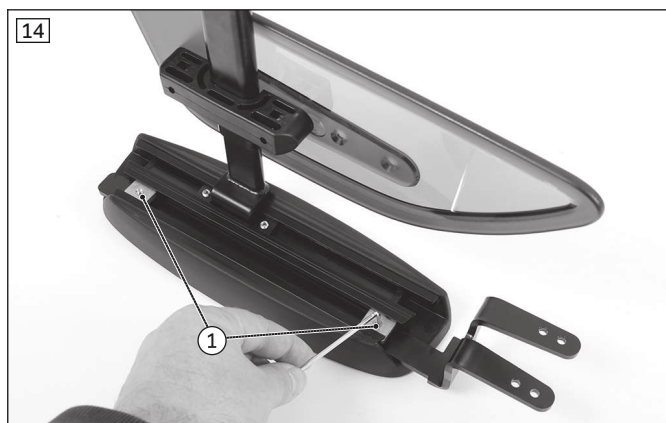

#### Adjusting the depth of the control panel position

- 1) Loosen the set screws on the bottom of the armrest (see fig. 14, item 1).
- 2) Slide the rail with the control panel forwards or backwards.

**INFORMATION: If the control panel rail is too long it can be shortened. Please contact the qualified personnel who adjusted your product.**

- 3) Tighten the set screws on the bottom of the armrest.

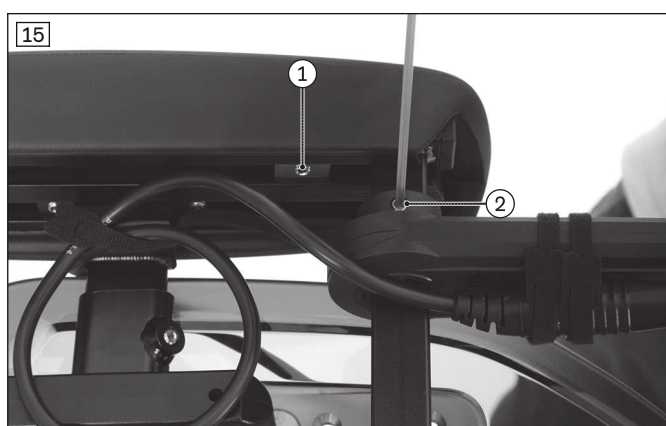

#### Adjusting the depth of the control panel position

- 1) Loosen the set screws on the bottom of the armrest (see fig. 15, item 1).
- 2) Slide the rail with the control panel forwards or backwards.

**INFORMATION: If the control panel rail is too long it can be shortened. Please contact the qualified personnel who adjusted your product.**

- 3) Tighten the set screws on the bottom of the armrest.

#### Adjusting the height of the control panel position

- 1) Loosen the set screw on the height adjustment (see fig. 15, item 2).
- 2) Adjust the height.
- 3) Tighten the set screw on the height adjustment.

## 7.3 Legrests

### INFORMATION

- ▶ Please note that Ottobock has delivered this power wheelchair without legrests as per the order.
- ▶ Prior to using the legrests from another manufacturer, please read and observe the instructions for use / manufacturer's instructions from the other manufacturer. These are included with the instructions for use.
- ▶ In case of questions or problems with these accessories, please contact the qualified personnel who adjusted this product.
- ▶ Ottobock assumes no liability for combinations with accessories from other manufacturers not included in Ottobock's modular system.

The legrests support the user's feet.

The height of the legrests has been adjusted by qualified personnel to the length of the user's lower leg.

The angle of the footrest has been set by the qualified personnel so that it allows the ankles to rest in a comfortable position.

### 7.3.1 Removing/installing the leg supports

#### CAUTION

#### Incorrect handling when getting in

Crushing, pinching, impacts due to incorrect handling

- ▶ Do not reach into the danger area with your fingers when folding the legrest or footplates up or down.
- ▶ Never step on the footplates when getting in and out.
- ▶ Note projecting edges.

### INFORMATION

For detaching/attaching the power legrests: see page 77.

**INFORMATION**

For detaching/attaching the mechanically elevating leg supports: see page 82.

The leg supports can be removed if needed to make getting in and out easier or for transportation.

The centrally mounted leg support cannot be removed. The foot supports can be folded up to make getting in and out easier or for transportation. Their central mounting position makes it possible to get into and out of the power wheelchair from the side (see page 28).

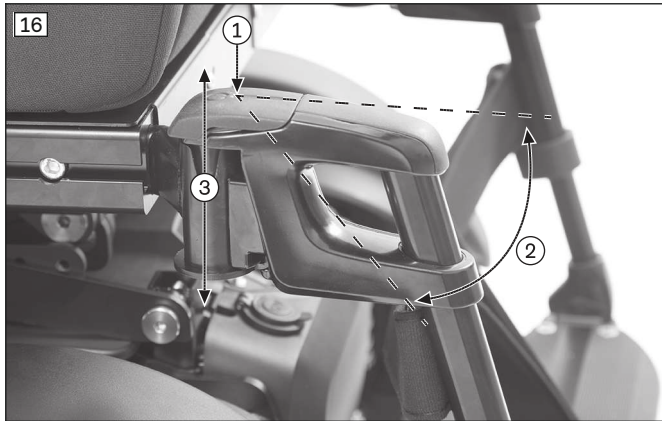
**Removing the legrests**

- 1) Fold up the footplate.
- 2) Push the legrest locking mechanism back and down (see fig. 16, item 1).
- 3) Swing out the legrest (see fig. 16, item 2).
- 4) Pull the legrest up and remove it (see fig. 16, item 3).

**Installing the legrests**

- 1) Engage the legrest in the holder straight from above (see fig. 16, item 3).
- 2) Push the legrest to the inside (see fig. 16, item 2) until the locking mechanism engages (see fig. 16, item 1).
- 3) Fold down the footplate.

**7.3.2 Adjusting the leg supports****⚠ CAUTION****Exposed pinch points**

Crushing, pinching due to incorrect handling

- ▶ Do not reach into the danger area with your fingers when folding the legrest or footplates up or down.

**⚠ CAUTION****Improper adjustment of the leg supports and foot plates**

Risk of injuries due to uncontrolled driving characteristics, damage to the product

- ▶ Make sure that the clearance between the foot plates and ground is sufficient even under load.
- ▶ Make sure that the leg supports and foot plates do not come into contact with the caster wheels under load.

The legrests can be subsequently adjusted to the requirements of the user.

**Adjusting the lower leg length**

- 1) **If present:** Remove the calf strap (not illustrated).
- 2) Loosen the set screw on the inside of the footplate bar (see fig. 17, item 1).
- 3) Adjust the footplate bar to match the user's lower leg length.

**INFORMATION: Ensure that the footplate bar is inserted into the swivel segment up to at least the marking (= 50 mm).**

- 4) Retighten the set screw on the footplate bar.
- INFORMATION: Always adjust both legrests.**
- 5) Hook the calf strap in again.



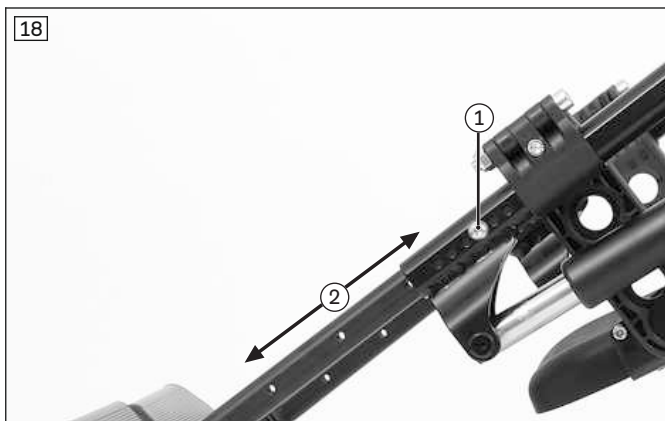

### Adjusting the lower leg length

- 1) Loosen the Allen head screw on the leg support bracket (see fig. 18, item 1).
- 2) Adjust the height of the foot support to match the user's lower leg length (see fig. 18, item 2).
- 3) Retighten the Allen head screw on the leg support bracket.

**INFORMATION: Always adjust both leg supports.**



### Adjusting the foot support angle

- 1) Loosen the Allen head screw on the foot support.
- 2) Turn the foot support to the desired angle.
- 3) Tighten the Allen head screw.



### Adjusting the foot support angle

- 1) Loosen the Allen head screw on the foot support.
- 2) Turn the foot support to the desired angle.
- 3) Tighten the Allen head screw.

### INFORMATION

Please note that the following work requires a torque wrench in order to properly tighten the screws according to the specifications. Otherwise, have qualified personnel carry out the adjustments.

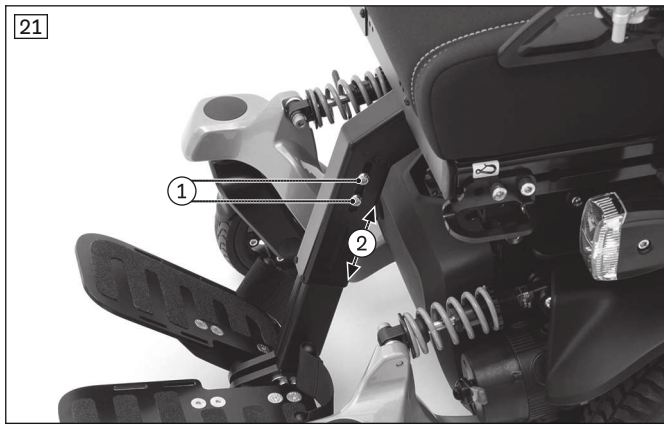

### Adjusting the lower leg length

- 1) Loosen the four Allen head screws on the rectangular socket of the centrally mounted leg support (see fig. 21, item 1).
- 2) Adjust the foot support bracket to match the user's lower leg length (see fig. 21, item 2). If necessary, remove the Allen head screws and insert them into the other elongated hole.

**CAUTION! Observe the ground clearance. There must be a clearance of at least 60 mm between the bottom of the foot supports and the ground.**

- 3) Tighten the Allen head screws on the rectangular socket to **25 Nm**.



### Adjusting the foot support angle

The angle of the foot supports (see fig. 22, item 1) can be adjusted by moving the stop plates.

- 1) Loosen the Allen head screws on the stop plate (see fig. 22, item 2).
- 2) Move the stop plate using the elongated hole (see fig. 22, item 3). The farther the stop plate is moved in the direction of the seat, the more the foot support angle increases.
- 3) Tighten the Allen head screws to **10 Nm**.

## 7.4 Backrest

### CAUTION

#### Exposed pinch points

Crushing, pinching due to incorrect handling

- ▶ Do not reach into the danger area with your fingers when folding the backrest up or down.

### INFORMATION

Detailed information regarding use when equipped with an ADI back support (Baxx line) can be found in the separate, enclosed instructions for use.

The backrest provides pressure redistribution and support for the upper body.

### 7.4.1 Folding the back support up/down

The wheelchair may be delivered with the backrest folded down. It has to be folded up and secured prior to use.

Folding the back support up/down on the Recaro® seat: see page 71.



### Folding up the backrest

- 1) Pull on the strap until the locking bolts are free (see fig. 23, item 1).
- 2) Lift the backrest and move it to the desired position.
- 3) Allow the locking bolts to engage.
- 4) Check to ensure the lock is securely engaged by pulling on the backrest.

### Folding down the backrest

- 1) Pull on the strap until the locking bolts are free (see fig. 23, item 1).
- 2) Lay the backrest down on the seat.



### Folding up the back support

- 1) Fold the back support up.
- 2) Push the lock lever down (see fig. 24, item 1).
- 3) Place the cross bolt on the end of the actuator into the bracket (see fig. 24, item 2).
- 4) Release the lock lever until the cross bolt engages.
- 5) Check to ensure the lock is securely engaged by pulling on the back support.

### Folding down the back support

- 1) Push the lock lever down (see fig. 24, item 1).
- 2) Release the cross bolt on the end of the actuator from the bracket (see fig. 24, item 2).
- 3) Fold the back support down onto the seat.



### Folding up the backrest

- 1) Pull on the strap until the locking bolts are free (see fig. 25, item 1).
- 2) Lift the backrest and move it to the desired position.
- 3) Allow the locking bolts to engage.
- 4) Check to ensure the lock is securely engaged by pulling on the backrest.

### Folding down the backrest

- 1) Pull on the strap until the locking bolts are free (see fig. 25, item 1).
- 2) Lay the backrest down on the seat.



### Folding up the backrest

- 1) **If needed:** Remove the side panels.
- 2) Fold the backrest up.
- 3) Insert the cotter pin (see fig. 26, item 1).
- 4) Lock the cotter pin (see fig. 26, item 2).
- 5) Check to ensure the lock is securely engaged by pulling on the backrest.
- 6) **If needed:** Reinstall the side panels.

### Folding down the backrest

- 1) **If needed:** Remove the side panels.
- 2) Unlock the cotter pin (see fig. 26, item 2).
- 3) Pull out the cotter pin (see fig. 26, item 1).
- 4) Lay the backrest down on the seat.
- 5) **If needed:** Reinstall the side panels.

## 7.4.2 Adjusting the back support angle

The back angle can be adapted to the particular needs of the user.

### Adjusting the back angle using the strap

- 1) Pull on the strap until the locking bolts are free (see fig. 23, item 1).
- 2) Move the backrest to the desired position.
- 3) Allow the locking bolts to engage.
- 4) Check to ensure the lock is securely engaged.

### Adjusting the back angle using the strap

- 1) Pull on the strap until the locking bolts are free (see fig. 25, item 1).
- 2) Move the backrest to the desired position.
- 3) Allow the locking bolts to engage.

- 4) Check to ensure the lock is securely engaged.

### Power back angle adjustment

The back angle is adjusted as needed by using this seat function (see page 76).

### Recaro® seat

The back angle is adjusted using a knob (see page 71).

## 7.5 Getting in and transferring

### ⚠ CAUTION

#### Incorrect handling when getting in

Falling, tipping over due to incorrect handling

- ▶ Turn the control unit off while getting in and out, in order to avoid accidental driving.
- ▶ Always place the seat in a horizontal position.
- ▶ Note that the armrests are not capable of bearing full body weight, and therefore must not be used for getting into or out of the wheelchair.
- ▶ Always put on a lap belt when driving.

### ⚠ CAUTION

#### Incorrect handling when getting in

Crushing, pinching, impacts due to incorrect handling

- ▶ Do not reach into the danger area with your fingers when folding the legrest or footplates up or down.
- ▶ Never step on the footplates when getting in and out.
- ▶ Note projecting edges.

The modular design of the power wheelchair and the ease with which you can remove the side panels and legrests make it easy to get into and out of the wheelchair from the side or from the front.

Users can choose the method for getting into and out of the wheelchair which is most suitable for them.

When the centrally mounted leg support is used, it makes sense to always get in the wheelchair from the side (see below).

To make it easier to get in, the foot supports should also be folded up until they touch the attachment.

**INFORMATION: If the foot supports cannot be folded easily without resistance, the mounting screws should be tightened slightly. Contact the qualified personnel if necessary.**

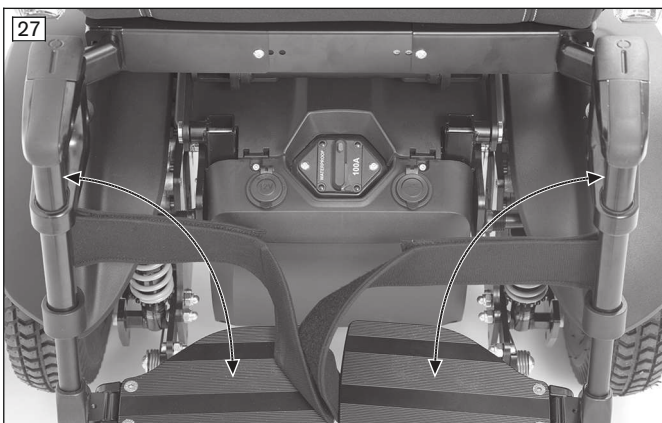

#### Getting in from the front

- 1) Turn the control device off.
- 2) Fold up the foot supports (see fig. 27) or remove the leg supports (see page 23).
- 3) Have an attendant assist you or use a transfer lifter to get into or out of the power wheelchair.
- 4) Install the leg supports. Fold down the foot supports.

#### Getting in from the side (alternative option)

- 1) Turn the control device off.
- 2) Remove or fold up the side panel (see page 20).
- 3) **If needed:** Remove the corresponding leg support.
- 4) Get into or out of the power wheelchair from the side. A ramp makes this easier.
- 5) Reinstall the leg support and side panel and fold down the foot support.



### Getting in from the front

- 1) Turn the control device off.
- 2) Fold up the foot supports (see fig. 28) or remove the leg supports (see page 23).
- 3) Have an attendant assist you or use a transfer lifter to get into or out of the power wheelchair.
- 4) Install the leg supports. Fold down the foot supports.

### Getting in from the side (alternative option)

- 1) Turn the control device off.
- 2) Remove or fold up the side panel (see page 20).
- 3) **If needed:** Remove the corresponding leg support.
- 4) Get into or out of the power wheelchair from the side. A ramp makes this easier.
- 5) Reinstall the leg support and side panel and fold down the foot support.



### Getting in from the side

- 1) Turn the control device off.
- 2) Remove or fold up the side panel (see page 20).
- 3) **If needed:** Fold up the foot support in question towards the back until the stop (see fig. 29).
- 4) Get into or out of the power wheelchair from the side. A ramp makes this easier.
- 5) Fold down the foot support towards the front until the stop and reinstall the side panel.

## 7.6 Control unit

### 7.6.1 VR2 control unit

#### **CAUTION**

#### **Uncontrolled driving behaviour**

Falling, tipping, collision with persons or nearby objects due to interference from electromagnetic fields

- ▶ Observe the information in the section "Interference due to electromagnetic fields" (see page 13).
- ▶ Turn the control device off when it is not needed.

The power wheelchair is controlled by a VR2 control unit.

The qualified personnel can subsequently adapt some parameters of the control device to the personal requirements of the user, for example, the speed, acceleration and deceleration values.

#### **7.6.1.1 Control panel**

The power wheelchair is operated using the control panel.

The control panel is divided into the keypad, two LED displays and the joystick. The charging/programming receptacle is on the underside.

The control panel is used to switch the power wheelchair on and off, enter driving commands and display the current status of certain functions and components.

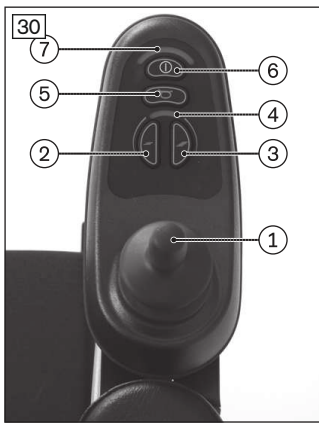

- 1 Joystick
- 2 [Decrease speed] button
- 3 [Increase speed] button
- 4 [Selected speed level] LED display
- 5 [Horn] button
- 6 [On/off] button
- 7 [Charge level] LED display
- 8 Charging/programming receptacle

**7.6.1.1.1 Buttons and display functions**

**Joystick**

The speed and driving direction are controlled with the joystick (see page 58).

**[On/off] button**

Pressing this button turns the power wheelchair on or off (see page 56). In combination with additional operating steps, it also activates/deactivates the drive-away lock (see page 59).

**[Decrease speed] and [Increase speed] buttons**

Pressing the button briefly increases/decreases the speed level (see page 57). The acoustic signal changes when the maximum speed level is reached.

**[Horn] button**

The horn will sound as long as the button is pressed.

**[Selected speed level] LED display**



The LED display shows the currently selected speed level (1–5).



**[Charge level] LED display**

The [Charge level] LED display is divided into 10 segments and shows the current charge level:

- The accuracy of the indicator increases after driving for a short time.
- A charge of 100% corresponds to 10 segments on the battery icon.
- As the remaining battery charge decreases, the LED segments turn off one by one.
- If only one segment of the LED display is flashing, then the battery is in an undervoltage state. The battery must be charged immediately.
- If all 10 LED segments are flashing, this means that the battery is in an overvoltage state. Please continue to drive at low speed only.
- The charging process is indicated by sequential flashing of the LEDs. The driving function is blocked when the battery is charging.

**Battery indicator on the control panel**

Display	Information
	Battery is charged
	Charge battery if possible
 Sequential indicator	Battery is charging

Display	Information
 <p>Flashing light</p>	Battery undervoltage, battery charging urgently required
 <p>Flashing light</p>	Battery overvoltage

### Further LED display functions

Further LED display symbols are described in the following sections:

- Section "Selecting the speed levels" (see page 57)
- Section "Drive-away lock" (see page 59)
- Section "Troubleshooting" (see page 125)

#### 7.6.1.2 Control panel

The power wheelchair is operated using the control panel.

The control panel is divided into the keypad, two LED displays and the joystick. The charging/programming receptacle is on the underside.

The control panel is used to switch the power wheelchair on and off, enter driving commands and display the current status of certain functions and components.

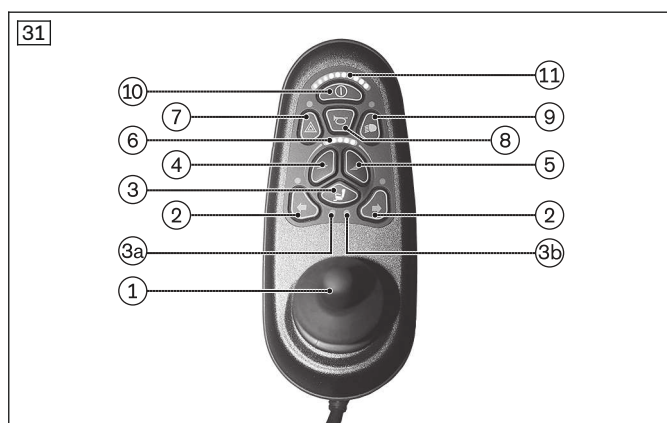

- 1 Joystick
- 2 [Direction indicator left/right] button
- 3 [Select additional power function] button  
3a: [Seat function 1] LED display  
3b: [Seat function 2] LED display
- 4 [Decrease speed] button
- 5 [Increase speed] button
- 6 [Selected speed level] LED display
- 7 [Warning flasher on/off] button
- 8 [Horn] button
- 9 [Lights on/off] button
- 10 [On/off] button
- 11 [Charge level] LED display
- Charging/programming receptacle (on the back)

#### 7.6.1.2.1 Buttons and display functions

##### Joystick

The speed and driving direction are controlled with the joystick (see page 58).

When a power seat option is activated, the joystick adjusts this seat option (see page 79).

##### [On/Off] button

Pressing this button turns the power wheelchair on or off (see page 56). In combination with additional operating steps, it also activates/deactivates the drive-away lock (see page 59).

##### [Slow Speed] and [Fast Speed] buttons

Pressing the button briefly increases/decreases the speed level (see page 57). The acoustic signal changes when the maximum speed level is reached.

##### [Select additional power functions] button

Pressing this button toggles through seat function 1 – seat function 2 – no seat function. The selected seat function is indicated by the LED.

**[Seat function 1/2] LED display**

This LED display shows the currently active additional power function.

**[Horn] button**

The horn sounds as long as the button is pressed.

**[Warning flasher on/off] button**

All 4 warning flashers are activated/deactivated when this button is pressed.

If the wheelchair is not fitted with lights for road traffic, this button is deactivated (no function).

**[Lights on/off] button**

The front and rear lights are activated/deactivated by pressing this button.

If the wheelchair is not fitted with lights for road traffic, this button is deactivated (no function).

**[Direction indicator right] and [Direction indicator left] buttons**

Pressing this button activates/deactivates the respective front and rear direction indicators.

If the wheelchair is not fitted with lights for road traffic, this button is deactivated (no function).

**[Selected speed level] LED display**

The LED display shows the currently selected speed level (1–5, see page 57).

A currently active automatic speed reduction (e.g. because a seat function was activated) is also displayed here:





Display	Information
 Flashing light	Restricted speed (creep speed)

**[Charge level] LED display**

The [Charge level] LED display is divided into 10 segments and shows the current charge level:

- The accuracy of the indicator increases after driving for a short time.
- A charge of 100% corresponds to 10 segments on the battery icon.
- As the remaining battery charge decreases, the LED segments turn off one by one.
- If only one segment of the LED display is flashing, then the battery is in an undervoltage state. The battery must be charged immediately.
- If all 10 LED segments are flashing, this means that the battery is in an overvoltage state. Please continue to drive at low speed only.
- The charging process is indicated by sequential flashing of the LEDs. The driving function is blocked when the battery is charging.

**Battery indicator on the control panel**

Display	Information
	Battery is charged
	Charge battery if possible
 Sequential indicator	Battery is charging
 Flashing light	Battery undervoltage, battery charging urgently required



Display	Information
 <p>Flashing light</p>	Battery overvoltage

### Further LED display functions

Further LED display symbols are described in the following sections:

- Section "Selecting the speed levels" (see page 57)
- Section "Drive-away lock" (see page 59)
- Section "Troubleshooting" (see page 125)
- Section "Power seat functions" (see page 73)

## 7.6.2 R-Net control device with JSM-LED-L control panel

### ⚠ CAUTION

#### Uncontrolled driving behaviour

Falling, tipping, collision with persons or nearby objects due to interference from electromagnetic fields

- ▶ Observe the information in the section "Interference due to electromagnetic fields" (see page 13).
- ▶ Turn the control device off when it is not needed.

The power wheelchair is controlled by an R-Net control device in combination with the JSM-LED-L control panel. The qualified personnel can subsequently adapt some parameters of the control device to the personal requirements of the user, for example, the speed, acceleration and deceleration values.

### 7.6.2.1 Control panel

The power wheelchair is operated using the control panel.

The control panel consists of buttons, LED displays and the joystick. The charging/programming receptacle is on the underside.

The control panel is used to switch the power wheelchair on and off, enter driving commands and display the current status of certain functions and components.

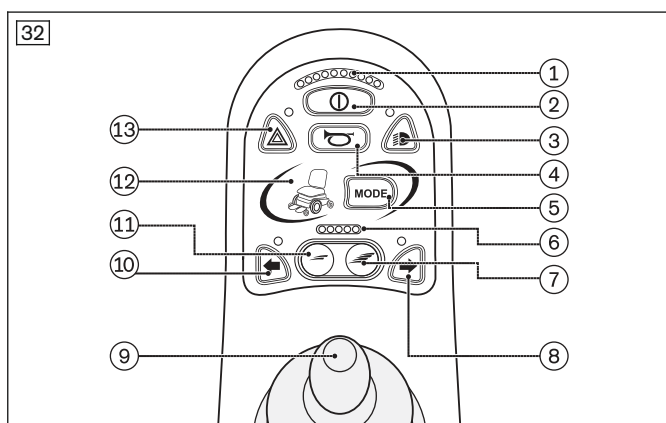

- 1 [Charge level] LED display
- 2 [On/off] button
- 3 [Lights on/off] button
- 4 [Horn] button
- 5 [Mode] button
- 6 [Selected speed level] / [Selected profile] LED display
- 7 [Increase speed] button
- 8 [Direction indicator right] button
- 9 Joystick
- 10 [Direction indicator left] button
- 11 [Decrease speed] button
- 12 [Selected seat function] LED display
- 13 [Warning flasher on/off] button
- Charging/programming receptacle (on the back)

### 7.6.2.2 Buttons and display functions

#### Joystick

The speed and driving direction are controlled with the joystick (see page 58).

If the control device is in "Power seat functions" mode, the seat function can be adjusted by moving the joystick forwards/backwards (see page 79) or switched to the next seat function by moving it left/right.

**[On/off] button**

Pressing this button turns the power wheelchair on or off (see page 56). In combination with additional operating steps, it also activates/deactivates the drive-away lock (see page 59).

**[Decrease speed] and [Increase speed] buttons**

Pressing the button briefly increases/decreases the speed level (see page 57).

Depending on the programming, the buttons can alternatively be used to select stored driving profiles. Up to five driving profiles can be programmed.

**[Mode] button**

Pressing the button switches the control device to the programmed mode (e.g. "Drive" mode or "Power seat functions" mode). When the control device is in the "Power seat functions" mode, the [Seat function] LED display shows the active seat function (see next paragraph).

**[Selected seat function] LED display**

The LED display shows the currently selected seat function. When the LED display is active, the seat function can be adjusted by moving the joystick forwards/backwards (see page 79) or switched to the next seat function by moving it left/right.

**[Selected speed level] or [Selected profile] LED display**

The LED display shows the currently selected speed level (1–5, see page 57).

Depending on the programming, the LED display can alternatively show the selected driving profile (1–5).

If an automatic speed reduction (e.g. because a seat function was activated) is currently active, this is also displayed here:

Display	Information
 Flashing light	Restricted speed (creep speed)

**[Horn] button**

The horn will sound as long as the button is pressed.

**[Lights on/off] button and LED**

The front and rear lights are activated/deactivated by pressing this button. The LED above the button lights up after activation.

If the wheelchair is not fitted with lights for road traffic, this button is deactivated (no function).

**[Warning flasher on/off] button and LED**

All four warning flashers are activated/deactivated when this button is pressed. The LED above the button lights up after activation.

If the wheelchair is not fitted with lights for road traffic, this button is deactivated (no function).

**[Direction indicator right] and [Direction indicator left] buttons and LED**

Pressing these buttons activates/deactivates the respective front and rear direction indicators. The LED above the button lights up after activation.





If the wheelchair is not fitted with lights for road traffic, this button is deactivated (no function).

**[Charge level] LED display**

The [Charge level] LED display is divided into 10 segments and shows the current charge level:

- After brief operation, the battery indicator shows the exact battery status.
- A charge of 100% corresponds to 10 segments on the battery symbol.
- As the remaining battery charge decreases, the LED segments turn off one by one.
- If only one segment of the LED display is flashing, then the battery is in an undervoltage state. The battery must be charged immediately.
- If all 10 LED segments are flashing, this means that the battery is in an overvoltage state. Please continue to drive at low speed only.
- The charging process is indicated by sequential flashing of the LEDs. The driving function is blocked when the battery is charging.

## Battery indicator on the control panel

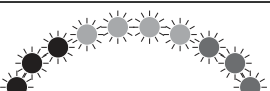
Display	Information
	Battery is charged
	Charge battery if possible
 Sequential indicator	Battery is charging
 Flashing light	Battery undervoltage, battery charging urgently required
 Flashing light	Battery overvoltage

### INFORMATION

At temperatures of **< 0 °C/32 °F** the battery capacity drops by up to **35%** in relation to the capacity for an outside temperature of **20 °C/68 °F**. This shortens the range of the power wheelchair accordingly. Moreover at low temperatures the charge level displayed on the control panel can differ more significantly from the actual battery capacity.

### Further LED display functions

Further LED display symbols are described in the following sections:

- Section "Selecting the speed levels" (see page 57)
- Section "Drive-away lock" (see page 59)
- Section "Troubleshooting" (see page 125)
- Section "Power seat functions" (see page 73)

### 7.6.2.3 Adjustment possibilities

The user cannot change any settings on the display.

### 7.6.3 R-Net control device with TEN° control panel/TEN° LCD module

#### ⚠ CAUTION

#### Uncontrolled driving behaviour

Falling, tipping, collision with persons or nearby objects due to interference from electromagnetic fields

- ▶ Observe the information in the section "Interference due to electromagnetic fields" (see page 13).
- ▶ Turn the control device off when it is not needed.

The power wheelchair is controlled by an R-Net control device.

The qualified personnel can subsequently adapt some parameters of the control device to the personal requirements of the user, for example, the speed, acceleration and deceleration values.

#### 7.6.3.1 TEN° control panel

#### INFORMATION

For the display functions on the LCD screen: see page 38.

The power wheelchair is operated using the control panel.

The control panel consists of a button section, LCD screen and joystick. The charging receptacle and two inputs for external buttons are located on the underside.

The control panel is used to switch the power wheelchair on and off, enter driving commands and display the current status of certain functions and components.

### Front side – TEN° control panel

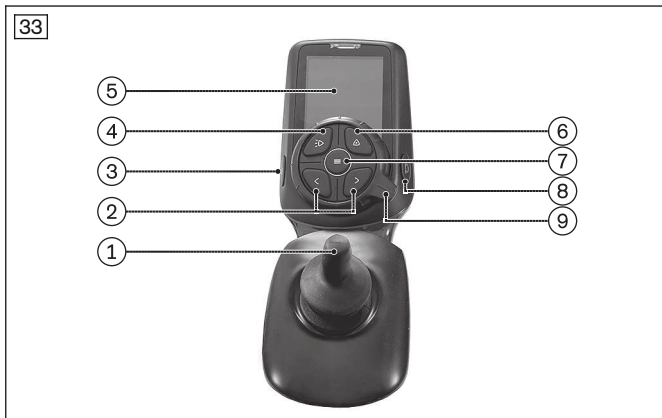

- 1 Joystick
- 2 [Direction indicator left – on/off] button  
[Direction indicator right – on/off] button
- 3 [On/off] button
- 4 [Lights on/off] button
- 5 LCD screen
- 6 [Warning flashers on/off] button
- 7 [Profile/mode] button
- 8 [Horn] button
- 9 Rotary multi-selector  
**right:** [Increase speed];  
**left:** [Decrease speed]

### Back side – TEN° control panel



- 1 Transmitter for infrared signals
- 2 Charging receptacle
- 3 Connection for external [Profile] or [Profile/mode] button (programmable)
- 4 Connection for external [on/off] button

#### 7.6.3.1.1 Push-button functions

##### Joystick

The speed and driving direction in a driving profile (e.g. "Drive") are controlled with the joystick (see page 58). If the control unit is in "Seating" mode, the seat option can be adjusted by moving the joystick forwards/backwards (see page 79) or switched to the next seat option by moving it left/right. You can navigate within the operating modes (e.g. "Bluetooth Devices" mode) by moving the joystick forwards/backwards or right/left.

##### [Direction indicator left – on/off] button; [Direction indicator right – on/off] button

Pressing these buttons activates/deactivates the respective front and rear direction indicators. If the power wheelchair is not fitted with lights for road traffic, this button is deactivated (no function).

##### [On/off] button

Pressing this button turns the power wheelchair on or off (see page 56). In combination with additional operating steps, it also activates/deactivates the drive-away lock (see page 59).

##### [Lights on/off] button

The front and rear lights are activated/deactivated by pressing this button. If the power wheelchair is not fitted with lights for road traffic, this button is deactivated (no function).

**[Warning flashers on/off] button**

All 4 warning flashers are activated or deactivated when this button is pressed.

If the power wheelchair is not fitted with lights for road traffic, this button is deactivated (no function).

**[Profile/mode] button**

Pressing this button retrieves the available driving profiles and operating modes of the control system in succession (dependent on programming and connected devices).

The system first switches from one driving profile to the next driving profile (e.g. "Drive"; "Speciality Control"; ...; "No Assist"; "Attendant"). The number of driving profiles is dependent on programming. After reaching the last driving profile, you can switch to the operating modes by pressing the button again.

The programmed operating modes are now toggled through ("Seating"; "Bluetooth Devices"; "IR Menu"; "I/O Module"). The number of operating modes is dependent on programming. The joystick is used to navigate within the operating modes (see above). After reaching the last mode, you can switch back to the first driving profile, "Drive", by pressing the button again.

**[Horn] button**

The horn sounds as long as the button is pressed.

**Rotary multi-selector right: [Increase speed]**

Moving the rotary multi-selector to the right increases the speed level (see page 57). The acoustic signal changes when the maximum speed level is reached. Depending on the programming of the control system, additional symbols may be displayed when the rotary multi-selector is operated.

**Rotary multi-selector left: [Decrease speed]**

Moving the rotary multi-selector to the left decreases the speed level (see page 57). The acoustic signal changes when the minimum speed level is reached. Depending on the programming of the control system, additional symbols may be displayed when the rotary multi-selector is operated.

**External piko buttons**

Connected on the control panel (see fig. 34, item 3/4).

The external piko buttons serve as an alternative switch for [On/Off] (see fig. 34, item 4) and [Profile/Mode] (see fig. 34, item 3). The functionality of the piko buttons corresponds to the functionality of the [On/Off] and [Profile/Mode] buttons as described above.

**7.6.3.2 TEN° LCD module****INFORMATION**

For the display functions on the LCD screen: see page 38.

**INFORMATION**

More detailed information and operating instructions are contained in a separate manual. Please contact the qualified personnel who adjusted your product.

The TEN° LCD module serves as the interface to one of the special control input devices and is used to control the power wheelchair in conjunction with that input device.

The TEN° LCD module is used to switch the power wheelchair on and off, enter driving commands and display the current status of certain functions and components.

## Basic structure – TEN° LCD module

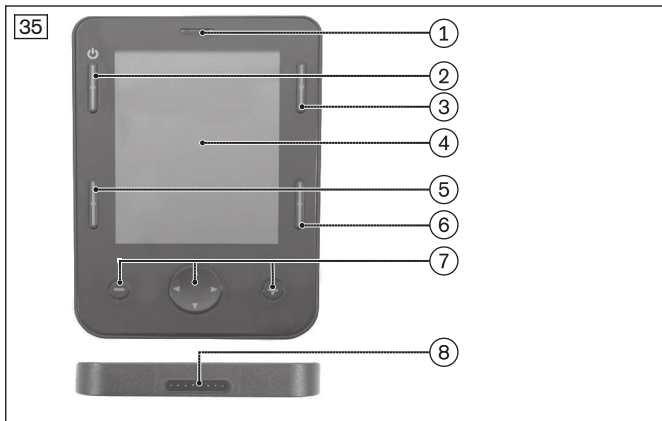

- 1 Receiver for infrared signals  
(On the back: transmitter for infrared signals)
- 2 [On/Off] button
- 3 [Settings] button
- 4 LCD screen
- 5 [Profiles] button
- 6 [Mode] button
- 7 Navigation buttons
- 8 Display module/connection module connection jack

### 7.6.3.2.1 Push-button functions

#### [On/Off] button

Pressing this button turns the power wheelchair on or off and activates/deactivates the drive-away lock. After switching on, the LCD screen displays the menu (see below).

#### [Settings] button

Pressing the button opens the Settings menu.

#### [Profiles] button

Briefly pressing the button switches from one profile to the next profile (e.g. "Drive"; "Specialty Control"; ... ; "No Assist"; "Attendant" -> depending on programming). After reaching the last profile, you can switch back to the first profile by pressing the button again.

#### [Mode] button

Pressing this button toggles through the programmed operating modes. As a rule the system starts with the "User Menu". All important functions can be called up from here (e.g. "Seating"; "Drive"; "Speed Adjust"; "Lights"; "Bluetooth Devices"; "IR Menu"; "I/O Module" -> depending on programming).

After reaching the last mode, you can switch back to the first mode by pressing the button again (generally "User Menu"). Use the navigation buttons on the connected input device (e.g. joystick, special control input devices) to navigate within the operating modes.

#### Navigation buttons

These buttons can be used by the qualified personnel to navigate through the settings and programming menus. The user can navigate through the programmed menus and select functions.

### 7.6.3.3 Display functions

#### INFORMATION

The displayed graphics and corresponding text descriptions can vary depending on the country and/or customer-specific configuration.

### LCD screen – TEN° control panel

The LCD screen is the communication interface between the user and the control device. It indicates the selected profile or the selected mode, the battery charge level and the status of power options and special functions as well as warnings and errors.



- 1 Display of the battery charge level (see next section)
- 2 Time display
- 3 Warning display (e.g. battery undervoltage)
- 4 Display of the profile name or the modes (e.g. **"Seating"**)
- 5 Display of the travel speed
- 6 Display of the distance travelled
- 7 Display of selected speed level
- 8 Display of active direction indicators (yellow) left/right [On/off]
- 8 Display of active warning flashers (red) [On/off]
- 9 Restricted speed (creep speed/drive-away lock)

### LCD screen – TEN° LCD module

The LCD screen is the communication interface between the user and the TEN° LCD module. It indicates the selected profile or the selected mode, the battery charge level and the status of power options and special functions as well as warnings and errors.

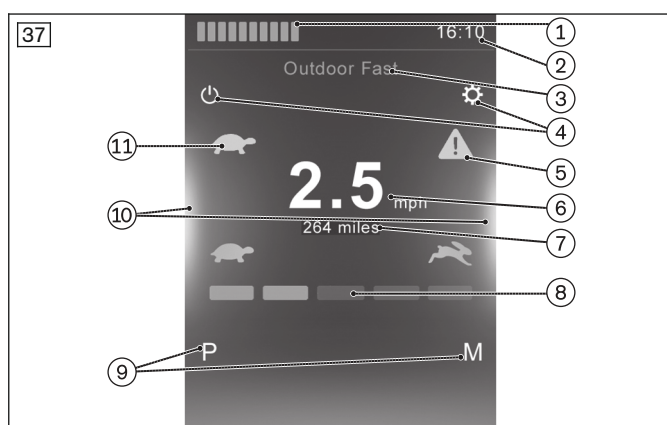

- 1 Display of the battery charge level (see next section)
- 2 Time display
- 3 Display of the profile name or the modes (e.g. **"Seating"**)
- 4 Display of the button function (left: [On/Off] button; right: [Settings] button)
- 5 Warning display (e.g. battery undervoltage)
- 6 Display of the travel speed
- 7 Display of the distance travelled
- 8 Display of selected speed level
- 9 Display of the button function (left: [Profile] button; right: [Mode] button)
- 10 Display of active direction indicators (yellow) left/right [On/off]
- 10 Display of active warning flashers (red) [On/off]
- 11 Restricted speed (creep speed/drive-away lock)

### User menu

#### INFORMATION

The scenario for standard programming is described below. The sequence of the sub-items can be varied individually by the qualified personnel.

The display shown above appears on the LCD screen of the TEN° LCD module after it is switched on.

After pressing a connected user switch for the first time, the User Menu is displayed. Alternatively the User Menu appears automatically after a programmed time interval.

The User Menu is a kind of "control centre" when the TEN° LCD module is used. Modes or submenus can be selected from here, the lights and horn can be operated, and settings can be configured. The functions and sub-functions are selected by moving to the right in the menus or scrolling up and down.

Scroll left/right or up and down in the menus using the respective installed input devices (e.g. joystick, navigation buttons on the TEN° LCD module, special control input devices).

Depending on the programming, the User Menu can offer the following functions:



Display	Function
"Drive" >	When selected, the control device switches to the "Drive" screen within the currently selected profile.
"Profile" <x>	Establishes the profile that is used the next time the "Drive" screen is opened.
"Seating" >	When selected, the control device switches to the displayed mode. This mode enables operation of the power seat functions delivered with the power wheelchair.
"Speed level" <x>	When selected, the speed level can be selected (e.g. speed level 1 – 5). The higher the speed level, the higher the speed.
"Horn"	When selected, the horn sounds.
"Speed Adjust" <x>	When selected, the speed level can be selected (e.g. speed level 1 – 5). The higher the speed level, the higher the speed.
"Mode x1" ... >	Depending on the programming, all available system modes can be shown in the list of the User Menu with their own entry, e.g. "Bluetooth Device" mode ("Bluetooth"), "IR Menu" mode ("Remote Control"). When selected, the control device switches to the displayed mode.
"Sleep" >	When selected, the control device switches to sleep mode.
"Lights" >	The lights or direction indicators can be turned on or off from here.
"Exit" >	Select to exit the User Menu. The "Drive" screen appears within the currently selected profile.
"Settings" >	Provides access to user settings (e.g. setting the back-light and time; see page ).

### Battery indicator [Charge level]



The battery indicator [Charge level] is divided into 10 segments and shows the current charge level:

- Immediately after the power wheelchair is switched on, the battery indicator shows the battery charge level that was saved before the wheelchair was last switched off.
- After brief operation, the battery indicator shows the exact battery status.
- A charge level of 100% corresponds to 10 segments on the battery indicator (blue bars).
- As the battery charge level decreases, the segments turn off one by one.
- If the battery indicator shows just red bars, either steady or flashing slowly, the batteries should be charged immediately.
- If the battery is in an undervoltage state, the LCD screen also shows the warning signal because further use will result in battery damage (see page 126). The battery must be charged immediately.
- If all 10 segments are flashing, this means that the battery is in an overvoltage state. Because further use will result in battery damage the warning signal is also shown on the LCD screen. Please continue to drive at low speed only.
- The charging process is indicated by the battery segments lighting up one after the other. The driving function is blocked when the battery is charging.



### Battery indicator [Charge level]

Display	Information
	Constant illumination – battery is charged (blue)
	Constant illumination – battery partially charged (orange)



Display	Information
	Slow flashing – charge battery immediately (red)
	Row of lights illuminating individually – charging in progress (red – orange – blue)



### Profile (selection) LCD screen



Display	Information
	<b>"Drive" profile</b> Standard driving profile. Among other things, the number of speed levels and the acceleration values are defined here. If there are special requirements for use, other driving profiles can be saved in the control device.
	<b>"Attendant" profile</b> This profile enables operation of an attendant control. The profile image appears automatically on the LCD screen when the attendant control is activated by the attendant.
	<b>"Specialty Control" profile</b> This profile enables operation of a special control (e.g. chin control, sip and puff control). The profile image appears automatically on the LCD screen when the special control is activated.

### Additional LCD display for model equipped with a gyro module









Display	Information
	<b>"No Assist" profile</b> The driving profile is only enabled for control devices with an electronic track stabiliser (gyro). For safety reasons, the user must activate this profile when travelling in means of transportation as the electronic track stabiliser is disrupted by the movement of means of transportation (bus; train; ship).









### LCD screen for operating modes



Display	Information
	<b>"Seating" mode</b> This mode enables operation of the power seat functions delivered with the power wheelchair. Further information: see page 79 ff.
	<b>"Bluetooth Device" mode</b> This mode enables control of PCs and smartphones/tablets with a Bluetooth function. The signals of installed input devices (such as a joystick, navigation buttons of the TEN° LCD module or special control input device) are used to control the device/mouse functions. The devices being controlled must be synchronised with the control device prior to use. Further information: see page 45 ff.

Display	Information
	<p><b>"IR Menu" mode</b></p> <p>This mode enables control of devices with infrared remote control – e.g. TV, DVD players, projectors, etc.</p> <p>The devices being controlled must be synchronised with the control device prior to use. Synchronisation is performed by the qualified personnel.</p> <p>Further information: see page 50 ff.</p>
	<p><b>"IOM3" mode – option (designation can be individually adjusted by the qualified personnel)</b></p> <p>The mode enables wireless control of up to 6 receivers for building services – e.g. power outlets, light switches, blinds, etc.</p> <p>The devices being controlled must be synchronised with the control device prior to use. Synchronisation is performed by the qualified personnel.</p> <p>The mode alternatively enables use of a push-button module.</p> <p>The mode is only displayed when the option has been ordered.</p> <p>Further information: see page 103 ff.</p>

### Important LCD indicators

Display	Information
	Start-up screen when switching on
	<p>Restricted speed (creep speed)</p> <p><b>Turtle symbol lights up yellow:</b> automatic speed reduction (e.g. because a seat function was activated)</p>
	<p>Restricted speed (drive-away lock)</p> <p><b>Turtle symbol flashes red:</b> power wheelchair is prevented from driving (e.g. because a seat function was activated)</p>
	<p>Temperature warning</p> <p><b>Thermometer symbol lights up orange:</b> e.g. overheating due to excessive load</p>
	<p>Connected additional input device (e.g. attendant control)</p> <p><b>Symbol next to the battery indicator lights up green:</b> TEN° control panel or TEN° LCD module is active</p>
	<p>Connected additional input device (e.g. attendant control)</p> <p><b>Symbol next to the battery indicator lights up red:</b> additional input device is active</p>
	<p>Bluetooth device nearby</p> <p><b>Bluetooth symbol next to the clock lights up blue:</b> a programmed Bluetooth device is nearby and can be operated with the TEN° control panel or the TEN° LCD module (see page 45)</p>
	<p>Constant speed in forward/reverse direction (optional programming)</p> <p><b>"Latched speed" symbol active:</b> the power wheelchair accelerates up to the desired speed with a forward joystick movement and holds it (like cruise control); the wheelchair brakes when a brief joystick command is executed in the opposite direction; the wheelchair stops when the joystick is moved more than 50% in the opposite direction</p>
	<p>Constant speed in forward/reverse direction (optional programming)</p> <p><b>Alternative meaning:</b> "Stepped" parameter = with each brief forward joystick movement, the power wheelchair speeds up by one level (e.g. 33%, 66%, 100%) up to the maximum speed level; the wheelchair slows by one level (e.g. from 66% to 33%)</p>

Display	Information
	when a brief joystick movement is executed in the opposite direction; the wheelchair stops when the joystick is held in the opposite direction
<p data-bbox="204 259 363 282">Emergency Stop</p> 	Emergency stop: severe controller/control device and/or drive motor malfunction (see page 126)
<p data-bbox="204 472 363 495">Center Joystick</p> 	Joystick not in home position when the unit is turned on (see page 126)
<p data-bbox="236 685 331 707">Warning</p>  <p data-bbox="204 819 363 864">FM : 2C00 L1MP FM : 2C00 L1MP</p>	Error message with various information notices (see page 126)
<p data-bbox="260 898 308 920">Lock</p> 	Drive-away lock (see page 59)
<p data-bbox="244 1111 323 1133">Standby</p> 	The control device has to be restarted (symbol flashing)
<p data-bbox="260 1323 308 1346">Sleep</p> 	Sleep symbol (control device is about to switch to sleep mode)
	This symbol is displayed during configuration procedures Procedure successful
	This symbol is displayed during configuration procedures Procedure unsuccessful

Display	Information
	This symbol is displayed during configuration procedures Procedure running; please wait
	"Stop button" in latched drive mode (cruise control); the wheelchair brakes when a brief joystick command is executed in the opposite direction; the wheelchair stops when the joystick is moved more than 50% in the opposite direction Alternative: display with special controls

### Further LCD screen functions

Further LCD screen symbols are described in the following sections:

- Section "Selecting the speed levels" (see page 57)
- Section "Drive-away lock" (see page 59)
- Section "Troubleshooting" (see page 125)

### 7.6.3.4 Adjustment possibilities

The user can change settings on the display:

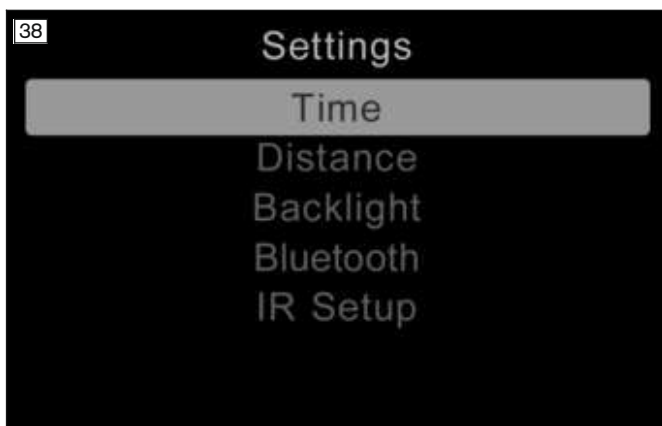

- **TEN° control panel only:** Press and hold the [Warning flashers on/off] button to call up the "Settings" menu.
- **TEN° LCD module only:** Press the [Settings] button to call up the "Settings" menu.
- Scroll up and down in the menus using the respective installed input devices (e.g. joystick, navigation buttons on the TEN° LCD module, special control input devices).
- The desired setting function (e.g. [Time]) is selected with the respective installed input devices by movements to the right.
- Specific settings (value changes) are made by further up/down or right/left movements with the respective installed input devices.
- **TEN° control panel only:** Some settings are configured by turning the rotary multi-selector to the left or right (see page 52).
- **TEN° LCD module only:** Some settings are configured using the navigation buttons +/- on the TEN° LCD module (see page 52)
- To save, the respective installed input devices are used to select the [Exit] menu item, which is confirmed with a movement to the right.

#### [Time] menu item >

The following submenus are displayed by moving the joystick to the right.

- [Set Time]: The displayed time can be changed with additional joystick movements here.
- [Display Time]: By moving the joystick to the left/right, the time display format can be changed or the display turned off. The available options are [12hr], [24hr] or [Off].
- [Exit]: Return to the **Settings** menu by moving the joystick to the right.

#### [Distance] menu item >

The following submenus are displayed by moving the joystick to the right.

- [Total Distance]: Display of the overall distance travelled with the control device.
- [Trip Distance]: Display of the distance travelled since the last reset to zero.
- [Display Distance]: Moving the joystick to the left/right determines whether the total distance or trip distance appears on the display.

- [Clear Trip Distance]: The trip distance can be erased by moving the joystick to the right.
- [Exit]: Return to the **Settings** menu by moving the joystick to the right.

#### [Backlight] menu item >

The following submenus are displayed by moving the joystick to the right.

- [Backlight]: The intensity of the LCD backlight can be adjusted by moving the joystick to the left/right. The adjustable range is 0 per cent to 100 per cent in steps of 10 per cent.
- [Autobacklight]: The available options Off and On can be selected by moving the joystick to the left/right. If set to On, the display adjusts the screen brightness based on a light sensor reading. If set to Off, the screen brightness will not change with changes in light intensity.
- [Backlight Timeout]: Automatic dimming of the backlight after a defined time period can be set by moving the joystick to the left/right. The setting is 0 to 240 seconds in increments of 5 seconds. A value of 0 seconds deactivates this function.
- [Exit]: Return to the **Settings** menu by moving the joystick to the right.

#### [Bluetooth] menu item

See the section "Environmental control via Bluetooth" (see page 45) for further information.

#### [IR Menu] menu item

See the section "Environmental control via infrared (IR)" (see page 50) for further information.

#### [Diagnostics] menu item

For qualified personnel only.

#### [Exit] menu item

Exit the **Settings** menu by moving the joystick to the right. The display switches to the first driving profile.

### 7.6.3.5 Environmental control via Bluetooth

#### NOTICE

##### Use of devices with electromagnetic emissions

Restriction of function due to electromagnetic fields

- ▶ The performance of the product can be affected by electromagnetic fields (highly radiating devices such as amateur radio or superimposed frequencies). If necessary, switch such devices off while using this product.

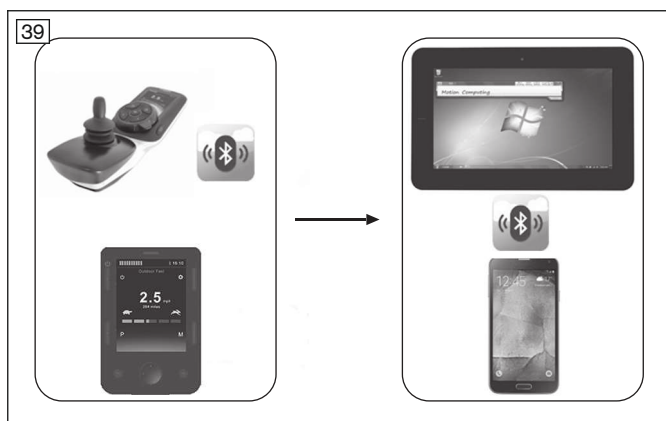

PCs (Windows) and tablets/smartphones (iOS devices; devices with Android 4.0 or higher) can be operated in "Bluetooth Devices" mode.

The signals of installed input devices (such as a joystick, navigation buttons on the TEN° LCD module, special control input device) are used to control the device/mouse functions.



#### 7.6.3.5.1 Activating devices

Before a connection to a Bluetooth device can be established, the device registration must be activated on the TEN° control panel or TEN° LCD module.

#### INFORMATION

Only activated device registrations are displayed in "Bluetooth Device" mode.

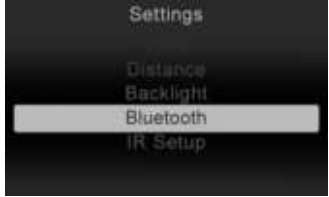
**LCD screen in "Settings" menu**

Display	Information
	<p><b>TEN° control panel:</b> Open the "Settings" menu by pressing and holding the [Warning flashers on/off] button and choose the [Bluetooth] item.</p> <p><b>TEN° LCD module:</b> Open the "Settings" menu by pressing the [Settings] button and choose the [Bluetooth] item.</p> <p>Navigate in the menu using the respective installed input device (e.g. joystick, navigation buttons on the TEN° LCD module, special control input devices):</p> <ul style="list-style-type: none"> <li>• Scroll through the list: move forward/back</li> <li>• Select entry: move to the right</li> </ul>
	<p>A list of preprogrammed device names and their respective activation status [On/Off] is displayed. Standard device names are PC, phone, iPhone and iPad. The names can be adjusted by the qualified personnel as desired.</p> <p>Select an appropriate device name for the device being activated.</p>
	<p>Set the activation status by moving right to &lt;On&gt; in the menu.</p> <p>Select [Exit] and return to the [Bluetooth] item by moving to the right in the menu.</p> <p>Select [Exit] again and leave the settings by moving to the right in the menu.</p> <p>Press the [On/Off] button to turn the control device off. Then restart the control device (several times if necessary).</p>

**7.6.3.5.2 Pairing**

**INFORMATION**

The name of the connected device (display name) can be customised by the qualified personnel (e.g. first name of the user, here "Tom").

Mutual authentication is required prior to initial Bluetooth communication between devices. This procedure, which needs to be carried out once for each device, is called "pairing".

The procedure, which can also be carried out by an attendant if necessary, is described below.

**Pairing with a PC**

**INFORMATION**

Because of the various operating system versions, some steps (searching for a Bluetooth device, adding a Bluetooth device, establishing a connection to the Bluetooth device) can only be described in very general terms. Also use the respective operating system help.

To pair with a PC, perform the following steps:

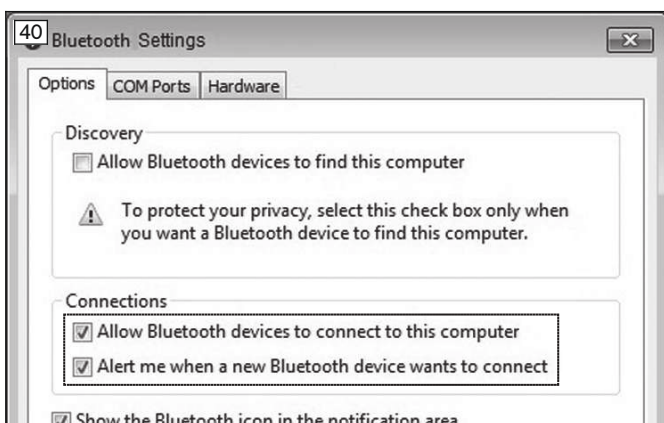

- > **Prerequisites:**
  - The device registration has been activated (see page 45).
  - Bluetooth devices can establish a connection to this computer. If necessary, right-click the Bluetooth symbol on the Windows interface of the PC (in the symbols at the bottom right next to the time) -> Open settings -> Tick checkbox (see fig. 40).
- 1) Turn on the wheelchair control device.
- 2) Select the "Bluetooth Devices" mode:
  - **TEN° control panel:** Press the [Profile/Mode] button a number of times if necessary.
  - **TEN° LCD module:** Press the [Mode] button a number of times if necessary.
  - A list of the available options for connecting to devices is displayed.

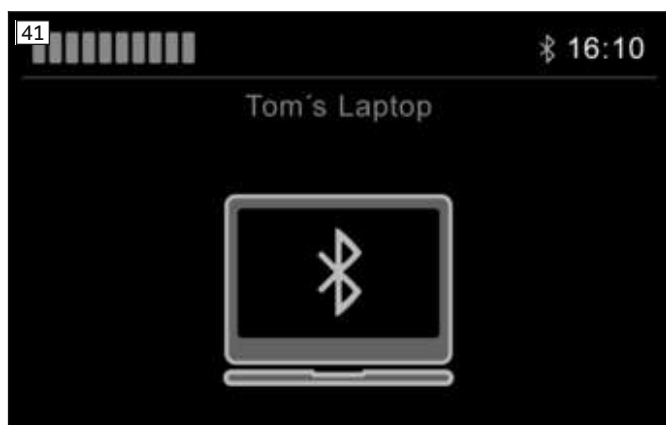

- 3) Start the pairing process by selecting a compatible device name, e.g. **Tom's laptop** (to scroll through the list: move forward/back; to select an item: move to the right)
  - The laptop symbol is displayed (see fig. 41).
- 4) Move the input device forwards for approx. 10 seconds until an acoustic signal sounds.
- 5) Move the input device back for approx. 10 seconds until an acoustic signal sounds.
  - The Bluetooth symbol at the top of the LCD screen (next to the time) should flash. The TEN° control device is ready to establish a connection.
- 6) Right-click the Bluetooth symbol on the PC (in the symbols at the bottom right next to the time) -> Open settings -> Add device.
- 7) Wait until the device name selected in step 3 is displayed in the "Add device" PC window and confirm. The pairing is now performed.

**INFORMATION: If additional Bluetooth devices are nearby, these are also displayed.**

- 8) After the device has been added successfully, the Bluetooth symbol is continually displayed in blue on the LCD screen. Now the PC can be operated using the respective installed input devices (e.g. joystick, navigation buttons on the TEN° LCD module, special control input devices).

**INFORMATION: If the connection is not established directly, call up "Bluetooth Device" mode again (see above).**

### Pairing with an Android device

#### INFORMATION

The details of the steps that follow and the menus that are shown may differ due to the variety of existing Android software versions. Also use the respective Android help.

To pair with an Android device (e.g. smartphone, tablet), complete the following steps:



- > **Prerequisite:** The device registration has been activated (see page 45).
- 1) Turn on the wheelchair control device.
- 2) On the Android device, open the **Settings** menu.
- 3) Under the item **Wireless and networks**, open the **Bluetooth** menu item and activate the Bluetooth function.
  - Alternatively, open the **Bluetooth** menu item directly and activate the Bluetooth function.
- 4) Select the "Bluetooth Devices" mode:
  - **TEN° control panel:** Press the [Profile/Mode] button a number of times if necessary.
  - **TEN° LCD module:** Press the [Mode] button a number of times if necessary.
  - A list of the available options for connecting to devices is displayed.
- 5) Start the pairing process by selecting a compatible device name, e.g. **Tom's tablet** (to scroll through list: move forwards/back; to select an item: move to the right).



- The tablet symbol is displayed (see illustration to the left).
- 6) Move the input device forwards for approx. 10 seconds until an acoustic signal sounds.
- 7) Move the input device back for approx. 10 seconds until an acoustic signal sounds.
  - The Bluetooth symbol at the top of the LCD screen (next to the time) should flash. The TEN° control device is ready to establish a connection.
- 8) Wait until the device name selected in step 5 is displayed on the Android device.
 

**WARNING! If additional Bluetooth devices are nearby, these are also displayed.**
- 9) Tap the device name displayed on the Android device to establish the pairing.
- 10) After the device has been added successfully, the Bluetooth symbol is continually displayed in blue on the LCD screen. Now the Android device can be operated using the respective installed input devices (e.g. joystick, navigation buttons on the TEN° LCD module, special control input devices).

## Pairing with an iDevice

### INFORMATION

Please observe the operating and configuration instructions of your iOS device. Additional changes to the device configuration may be necessary.

To pair with an iOS device (e.g. iPhone, iPad), perform the following steps:



- > **Prerequisite:** The device registration has been activated (see page 45).
- 1) Turn on the wheelchair control device.
- 2) Tap **Settings** > **Bluetooth** on the iOS device. Remain on this screen until the steps for pairing with the TEN° control device have been completed.
- 3) Select the "Bluetooth Devices" mode:
  - **TEN° control panel:** Press the [Profile/Mode] button a number of times if necessary.
  - **TEN° LCD module:** Press the [Mode] button a number of times if necessary.
  - A list of the available options for connecting to devices is displayed.
- 4) Start the pairing process by selecting a compatible device name, e.g. **Tom's iPhone** (to scroll through list: joystick forwards/back; to select an item: joystick to the right).
  - The iPhone symbol is displayed (see illustration to the left).
- 5) Move the input device forwards for approx. 10 seconds until an acoustic signal sounds.
- 6) Move the input device back for approx. 10 seconds until an acoustic signal sounds.
  - The Bluetooth symbol at the top of the LCD screen (next to the time) should flash. The TEN° control device is ready to establish a connection.







- 7) Wait until the device name selected in step 4 is displayed on the iOS device.  
**INFORMATION: If additional Bluetooth devices are nearby, these are also displayed.**
- 8) Tap the device name displayed on the iOS device to establish the pairing (see illustration to the left).
- 9) After the device has been added successfully, the Bluetooth symbol is continually displayed in blue on the LCD screen. Now the iOS device can be operated using the respective installed input devices (e.g. joystick, navigation buttons on the TEN° LCD module, special control input devices).

### 7.6.3.5.3 Selecting the connected devices

#### LCD screen in "Bluetooth Device" mode

Display	Information
	The pairing is maintained as soon as the Bluetooth connection to the devices has been established.
	The device can be selected by scrolling (forwards/back). The selection is confirmed by moving right/left.
	After a few seconds, a Bluetooth symbol is continually displayed in blue on the LCD screen. Now the device can be operated using the respective installed input devices (e.g. joystick, navigation buttons on the TEN° LCD module, special control input devices).

The ID of the devices to which a Bluetooth pairing has been established is retained in the control device. This means that the connection can also be reestablished automatically:

- if the wheelchair control device has been switched on again after being switched off,
- if the external device has been switched off and on again,
- if the wheelchair has been outside the Bluetooth visibility of the external device and then returns to the visible range again.

### 7.6.3.5.4 Deactivating devices

- 1) **TEN° control panel:** Open the "Settings" menu by pressing and holding the [Warning flashers on/off] button and choose the [Bluetooth] item.  
**TEN° LCD module:** Open the "Settings" menu by pressing the [Settings] button and choose the [Bluetooth] item.
- 2) Scroll to select the device you wish to deactivate from the list of available devices.
- 3) Confirm the selection by moving right in the menu.
  - The device registration is now displayed with the additional information <Off>.
  - The device can be activated again in the same manner. A new pairing is not required.

### 7.6.3.5.5 Operating mouse functions on a PC

Once a connection has been established to the PC, the mouse pointer can be controlled with the wheelchair control device.

### Mouse movements

The mouse pointer behaves according to the movement of the respective installed input device (e.g. joystick, navigation buttons on the TEN° LCD module, special control input devices):

- Mouse movement to the left/right: move mouse pointer to the left/right at normal speed using the input device.
- Mouse movement up/down: move mouse pointer forwards/back at normal speed using the input device.

### Mouse actions

Mouse actions (such as clicking, scrolling) can be carried out in two ways depending on the equipment.

a) Mouse actions by moving the input device quickly and briefly:

- Left mouse button function (choose selection): move the input device quickly and briefly to the left.
- Right mouse button function: move the input device quickly and briefly to the right.
- Scroll upwards: move the input device quickly and briefly to the front.
- Scroll downwards: move the input device quickly and briefly to the back.
- Double-click the left mouse button: quickly move the input device to the left twice in quick succession.
- Double-click the right mouse button: quickly move the input device to the right twice in quick succession.

The qualified personnel can also change assignments using individual programming, for example so that a single input device movement is interpreted as a double-click.

b) Mouse actions using external buttons:

- One button corresponds to the left mouse button, the other button corresponds to the right mouse button.
- Drag-and-drop is operated as with a traditional mouse: press and hold the button and drag with the joystick.

#### 7.6.3.5.6 Operating iOS device functions

The functions of the iOS device can be controlled using the respective installed input device (e.g. joystick, navigation buttons on the TEN° LCD module, special control input devices). The assignment can be programmed by the qualified personnel.

#### 7.6.3.5.7 Operating Android device functions

As soon as the pairing has been completed, a cursor is superimposed on the display of the Android device.

Similar to the PC, moving the respective installed input device produces a corresponding cursor movement on the display of the Android device.

Device functions such as taking phone calls, selecting contacts, accessing the Internet or sending text messages are selected by moving the cursor to the corresponding function and moving the input device quickly and briefly to the left.

#### 7.6.3.6 Environmental control via infrared (IR)

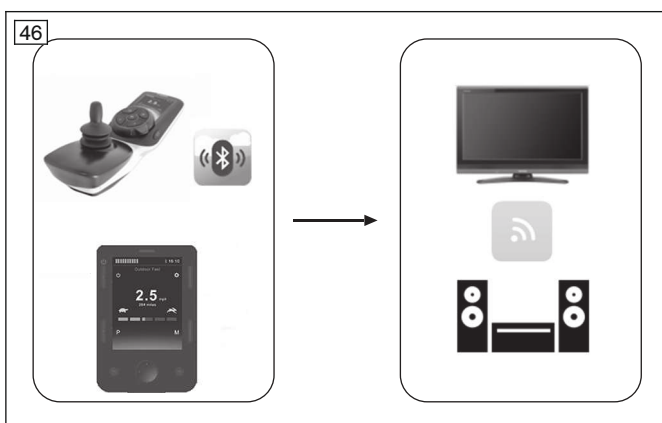

Devices with an infrared remote control (TV, audio, video, projectors, etc.) can be controlled in "IR Menu" mode.

The signals of installed input devices (such as a joystick, navigation buttons of the TEN° LCD module or special control input device) are used to control the device functions.

The device functions must be stored in the control device using a learning mode or programmed by the qualified personnel using a programming interface.

##### 7.6.3.6.1 Operating IR devices

#### Entering/exiting "IR Menu" mode

Enter/exit the environmental control mode for devices with infrared remote control as follows:

- **TEN° control panel:** Repeatedly pressing the [Profile/Mode] button calls up the profiles and operating modes in succession (see page 38; dependent on programming).
- **TEN° LCD module:** Repeatedly pressing the [Mode] button calls up the operating modes in succession (see page 38; dependent on programming).
- When "IR Menu" mode is reached, the programmed devices can be controlled in the home environment.



- Navigate in "IR Menu" mode using the respective installed input devices (e.g. joystick, navigation buttons on the TEN° LCD module, special control input devices).
- **TEN° control panel:** Pressing the [Profile/Mode] button again allows you to switch to further operating modes and back to the driving profiles (dependent on programming).
- **TEN° LCD module:** Pressing the [Mode] button again allows you to switch to further operating modes (dependent on programming).

### Operating devices

Proceed as follows to navigate in the "IR Menu":

- Scroll up and down in the list of devices that can be controlled using the respective installed input devices (e.g. joystick, special control input devices).
- Select a submenu for the corresponding menu item with a movement to the right or left.
- Moving to the right or left again triggers the selected control command.

### LCD screen in "IR Menu" mode

Display	Information
	When "IR Menu" mode is selected, a list of the devices that can be operated using environmental control is displayed.
	A list of assigned control commands (IR codes) is stored for each device. Using the example of a television set (TV), the following commands are available: [On], [Off], [Volume up], [Volume down], [Mute], [HDMI].
	When the selected command is issued using the respective installed input device, the list entry is highlighted red.

### 7.6.3.6.2 Learning and assigning IR codes

#### Programming devices

The "IR Menu" mode is only available if commands for controlling devices (IR codes) have been saved in the wheelchair control device. There are two methods for storing IR codes:







- "Learning" the IR code with the help of the corresponding remote control (see below),
- Programming with the PC-based IR configurator (only by qualified personnel).

#### Learning prerequisites

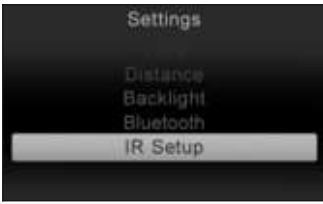
To allow an optimal learning procedure the following recommendations should be followed:

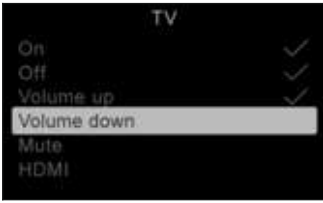
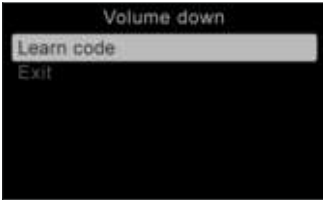
- Put new batteries in the remote control to ensure the IR signal is of good quality.
- Avoid directly exposing the IR sensor to daylight or lamps when signals are being transferred.
- Position the remote control directly in front of the control panel or the TEN° LCD module during the learning process. When pressing a button on the remote control, make sure that the remote control remains still (do not move it back and forth during learning). The ideal distance between the remote control and TEN° control panel or TEN° LCD module is in the range of **40 to 100 mm** (1.57" to 3.94").

## LCD screen in "Settings" menu

Display	Information
	<p><b>TEN° control panel:</b> Open the "Settings" menu by pressing and holding the [Warning flashers on/off] button.</p> <p><b>TEN° LCD module:</b> Open the "Settings" menu by pressing the [Settings] button. Using the respective installed input device (e.g. joystick, up/down and right/left navigation buttons on the TEN° LCD module, special control input devices), select the menu item [IR Setup].</p> <ul style="list-style-type: none"> <li>• Scroll through the list: move forward/back</li> <li>• Select entry: move to the right</li> </ul>
	Select a device, e.g. [TV]. The commands which have been set up for the device are displayed.
	Select the command which needs to be learned, e.g. [Volume down].
	Select [Learn code].
	Point the TV remote control towards the control panel or TEN° LCD module and press the desired button (e.g. [Volume down]) twice in succession. The learning progress is displayed on the control panel or TEN° LCD module in learning mode.
	<p><b>INFORMATION:</b> Hold the remote control at a distance of 40 to 100 mm (1.57" to 3.94") away from the receiver for infrared signals.</p> <p>The receiver is located on the front side of the TEN° control panel or TEN° LCD module above the LCD screen (see arrow).</p> <p><b>Notice:</b> The illustration shows the receiver for infrared signals on the TEN° control panel.</p>
	A tick mark indicates that the learning process was successful.
	If the learning process was not successful, an X is displayed. Repeat the learning process in this case.

## 7.6.3.6.3 Activating and deactivating IR codes

The learned IR codes can be activated or deactivated:

- Once an IR code is deactivated, it no longer appears in the user menu. The corresponding command (e.g. [Volume down]) can no longer be transmitted or executed.
- If an IR code is activated, it appears in the user menu. The corresponding command (e.g. [Volume down]) can be transmitted and executed.

### LCD screen in "Settings" menu

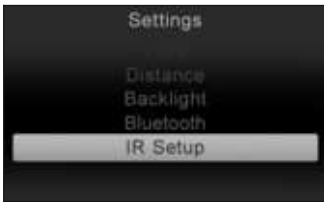
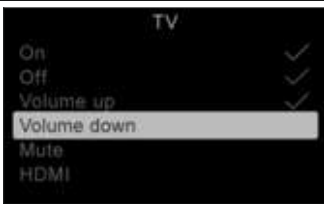
Display	Information
	<p><b>TEN° control panel:</b> Open the "Settings" menu by pressing and holding the [Warning flashers on/off] button.</p> <p><b>TEN° LCD module:</b> Open the "Settings" menu by pressing the [Settings] button. Using the respective installed input device (e.g. joystick, up/down and right/left navigation buttons on the TEN° LCD module, special control input devices), select the menu item [IR Setup].</p>
	<p><b>Deactivating an IR code</b></p> <p><b>TEN° control panel:</b> An IR code can be deactivated by turning the rotary multi-selector to the left.</p> <p><b>TEN° LCD module:</b> An IR code can be deactivated by a movement to the left in the menu using the respective installed input device (e.g. joystick, +/- navigation buttons on the TEN° LCD module, special control input devices). A deactivated IR code appears with an "X" next to the list entry.</p> <p><b>Activating an IR code</b></p> <p>An IR code can be activated by the respective movement to the right. An activated IR code appears with a tick mark next to the list entry.</p>

## 7.7 Driving functions

### 7.7.1 Safety instructions

#### Hazards while driving

##### CAUTION

##### Lack of riding experience

Collision, falling due to errors in handling the product

- ▶ Practise using the product on level, open ground first.

##### CAUTION

##### Insufficient support of the seated person

Risk of falling out of the power wheelchair due to lack of restraint

- ▶ Always use the installed belt system when driving in public.
- ▶ Information about subsequent acquisition and mounting is provided by the qualified personnel that handed the product over to you.

##### CAUTION

##### Uncontrolled driving behaviour, unexpected sounds or odours

Falling, tipping, collision with persons or nearby objects due to defects

- ▶ If any faults, defects or other hazards that can lead to personal injury are detected, the product must be taken out of service immediately. This includes uncontrolled movements as well as sounds that are unexpected or previously not noted or odours that deviate significantly from the state of the product at the time of delivery.
- ▶ Contact the qualified personnel.

##### CAUTION

##### Driving in the dark

Risk of collisions with other traffic participants due to lack of lighting

- ▶ Wear bright clothing or clothing with reflectors.
- ▶ Use the lights on the wheelchair.
- ▶ **If present:** Ensure that the reflectors on the rear marker plate on the product are clearly visible.

## Hazards during use of public transportation, elevators, lifting platforms

### ⚠ CAUTION

#### Use of elevators, lifting platforms

Risk of tipping, collision with persons or nearby objects due to incorrect parking

- ▶ Always turn the power wheelchair control unit off when using elevators or lifting platforms.
- ▶ Make sure that the brake is engaged.

### ⚠ CAUTION

#### Safe positioning when using public transit

Crushing, pinching, impacts, collision with persons or objects, damage to the product due to human error

- ▶ Only use public transit approved for the transportation of power wheelchairs.
- ▶ Always observe the current applicable transportation guidelines of the transit company and/or the legal requirements in your country when using public transit.
- ▶ Always ensure that you are held in place securely when travelling on public transit. To do so, use the wheelchair areas, wheelchair bays and restraint systems provided. Turn the power wheelchair off before the vehicle starts to move.
- ▶ The transportation of a person sitting in a wheelchair in public transit constitutes a significant safety risk for all participants. We therefore recommend using the seats provided during transportation.
- ▶ While using public transit, you are not permitted to sit in the wheelchair without an approved personal restraint system.

### INFORMATION

**Only for control units with an electronic track stabiliser (gyro):** The electronic track stabiliser is disrupted by the movement of the means of transportation (bus; train; ship) and therefore cannot function. If you must travel short distances in a moving means of transportation, please activate the "No assist" add-on profile. This switches off the electronic track stabiliser.

## Hazards due to defective tyres

### ⚠ CAUTION

#### Defective tyres

Accidents/falling due to poor traction, reduced braking force or lack of manoeuvrability

- ▶ Maintain sufficient tyre pressure. The correct air pressure is printed on the sidewall of the tyre.
- ▶ Ensure that the drive wheels have the same pressure.
- ▶ Ensure that the tyres have sufficient tread depth. The tyres must be changed when the tread depth is less than **1 mm**.

## Additional information

### INFORMATION

Even in the event of compliance with all applicable guidelines and standards, alarm systems (e.g. in department stores) may respond to your product. Should this happen, remove your product from the area where the alarm was triggered.

### INFORMATION

During use of the power wheelchair, electrical discharges (high voltage with low current; discharge via the user) may occur which are caused by factors such as friction. However, these do not represent a health hazard. Electrostatic discharge may also occur if the power wheelchair is equipped with puncture-proof tires. Retrofitting the wheelchair with pneumatic tires can correct this problem.

## 7.7.2 Driving notes

### General information:

- Prior to each use, the charge level of the batteries must be checked to avoid stalling due to drained batteries.
- Beginners should always drive at a low speed level.
- Always take curves slowly.

- On uneven ground, the driving behaviour of the wheelchair may get out of control. Therefore the speed must always be adjusted to the ground conditions.
- Driving backwards should be limited to manoeuvring and short distances on level ground.

**Obstacles (steps, curbs, tracks):**

- Always approach obstacles directly from the front (never at an angle with only one front wheel).
- Starting at a **maximum distance of 10 cm** from the obstacle is permissible.
- Always reduce speed to cross over obstacles (e.g. select speed level 1 or 2).
- Note the information on the critical obstacle height (see the section "Technical data"). Crossing over obstacles greater than the height difference specified there is not permitted.
- Avoid "jumping" down from higher surfaces.
- Do not lean out of the wheelchair while crossing obstacles.
- Only cross railway systems and railway tracks in the designated areas.
- Do not negotiate railroad crossings too close to the edge. Otherwise, the wheels could accidentally move off the railroad crossing.

**Inclines and gradients:**

- Note the information on permitted inclines and downgrades (see the section "Technical data"). Driving on inclines or downgrades exceeding the specified values is not permitted. The wheelchair may otherwise tilt and not brake safely. The traction of the drive wheels is also reduced.
- The control device and the motors must be protected against overloading. Therefore, the continuous climbing ability depends on the overall weight (wheelchair weight + user weight + load), as well as the ground conditions, exterior temperature, battery voltage and driving style of the user. In individual cases, the continuous climbing ability may be significantly lower than the value specified.
- In order to navigate downhill gradients safely, the speed must be reduced according to the slope (e.g. select speed level 1).
- Never drive downhill backwards. Only briefly manoeuvring on ramps is permitted (for example, when exiting a vehicle for transporting persons with reduced mobility).

**Terrain:**

- The speed must be reduced in dangerous areas (e.g. select speed level 1).
- Typical dangerous areas include:
  - Narrow paths along waterways/slopes/cliffs (e.g., quay walls, dikes, etc.)
  - Cramped rooms or areas
  - Steep downgrades (e.g., in the mountains, facing streets)
  - Unsurfaced areas (e.g., on construction sites, intersections, train crossings)
  - Snow-covered or icy areas
- The product may not be used in salt water.

**Using the control unit:**

- The control system always has to be mounted securely and the joystick position must be correct.
- The hand or limb used to operate the joystick should be supported, for example on the side panel arm pad.
- The joystick must not be used as the sole support for the hand or limb, because wheelchair movements and bumps could cause a loss of control.
- If the power wheelchair does not drive at full speed even when the battery is fully charged, the selected speed level should be checked. Contact the qualified personnel if increasing the speed level does not solve the problem.
- The intelligent speed control system minimises the effects of slopes and different types of terrain.

### Further instructions for use

- Attaching loads such as backpacks and the like can adversely affect stability. Ottobock recommends using a luggage carrier or the "Backpack hook" option. If this is not available, a backpack should always be secured to the back frame with the shoulder straps. The maximum load of **5 kg (11 lbs)** should not be exceeded.
- The recommended overall width for category B power wheelchairs when ready for operation is **700 mm (27.5")**. This specification should ensure unhindered use of escape routes, for example. Please note that the wheelchair dimensions may exceed the recommended value in variants with very large seat widths (for more information see the section "Technical data": see page 133).
- The wheelchairs in this series fully satisfy the minimum technical requirements for wheelchairs transportable by train. Please note, however, that due to the variety of variants and settings, not every specific power wheelchair will meet all minimum requirements (for more information see the section "Appendix" > "Threshold values for wheelchairs transportable by train": see page 143).

### 7.7.3 Switching on and off

#### **⚠ WARNING**

##### **Lack of brake functionality**

Falling, tipping over, collision with persons or nearby objects due to lack of inspection

- ▶ Ensure that the brake release lever is in the driving position every time before you drive (see page 61).
- ▶ Check the control unit display to ensure that the brakes are operational and functional (see page 126).

#### **⚠ WARNING**

##### **Defective safety functions**

Falling, tipping over, collision with persons or nearby objects due to lack of inspection

- ▶ Before every use, ensure that the product and its safety functions are in safe and proper condition.
- ▶ Only use the product if all safety functions, e.g. the automatic brakes, are functional.

#### **⚠ WARNING**

##### **Unexpected emergency stop**

Falling, the user may fall out due to sudden emergency braking

- ▶ In the event of communication problems in the control device bus system or a power supply defect, the system triggers an emergency stop and thus avoids uncontrolled functions.
- ▶ Note that this emergency stop in road traffic could lead to situations that are hazardous for you. Ensure that the control device is maintained regularly (see page 123).
- ▶ Note that after every emergency stop, you have to turn the power wheelchair control device on again.
- ▶ If the driving function is still not available after turning the control device on again, pushing mode can be activated by releasing the brake (see page 61).
- ▶ Consult the qualified personnel promptly if the driving function is not available after restarting.

#### **INFORMATION**

In dangerous situations, the product can be turned off at any time using the on/off button. When the button is pressed, the product brakes immediately and the electrical functions cease. Malfunctions such as an insufficient supply of power to the controls are recognised by the software, triggering an emergency stop or reducing the speed of the product. A warning signal will also sound.

- Pressing the [On/Off] button (see page 29) turns the power wheelchair control device on or off. The power wheelchair turns off automatically if the control device has not been used for an extended period of time.
- The power wheelchair brakes automatically and comes to a stop if it is turned off with the [On/Off] button while being driven.
- Each time you switch on the control device, it will be at the previously selected speed level.
- Pressing the [On/Off] button (see page 29) turns the power wheelchair control device on or off. The power wheelchair turns off automatically if the control device has not been used for an extended period of time.
- The power wheelchair brakes automatically and comes to a stop if it is turned off with the [On/off] button while being driven.
- Each time you switch on the control device, it will return to the previously selected speed level by default.
- The specialist dealer can use the parameter settings to specify the default speed level or default menu of the power wheelchair after it is turned on, according to the user's requirements.



- Pressing the [On/off] button (see page 29) turns the power wheelchair control device on or off. The power wheelchair turns off automatically if the control device has not been used for an extended period of time.
- The power wheelchair brakes automatically and comes to a stop if it is turned off with the [On/off] button while being driven.
- Each time you switch on the control device, it will return by default to the last driving profile used (e.g. "Drive") or to the last mode used (e.g. "Seating").
- The qualified personnel can use the parameter settings to specify the default driving profile or mode of the power wheelchair after it is turned on according to the user's requirements (e.g. in the "Drive" profile).

#### 7.7.4 Selecting the speed levels

- The power wheelchair has a programmable number of speed levels (delivery condition = 5 speed levels).
- Pressing the [Decrease Speed] button lowers the speed level.
- Pressing the [Increase Speed] button raises the speed level.
- The pitch of the audible signal changes once the highest or lowest speed level is reached.
- The [Selected speed level] LED display shows the speed level selected.

Display	Information
	Selected speed level = 3

- The power wheelchair has a programmable number of speed levels (delivery condition = 5 speed levels).
- Pressing the [Decrease speed] button lowers the speed level.
- Pressing the [Increase speed] button raises the speed level.
- The pitch of the audible signal changes once the highest or lowest speed level is reached.
- The LCD screen indicates the selected speed level in the **Driving** menu:

Display	Information
	Selected speed level = 3 (JSM-LED-L control panel)

#### Procedure with TEN° control panel

- The power wheelchair has a programmable number of speed levels (delivery condition = 5 speed levels).
- Turning the rotary multi-selector to the right [Increase speed] increases the speed level.
- Turning the rotary multi-selector to the left [Decrease speed] reduces the speed level.
- The pitch of the audible signal changes once the highest or lowest speed level is reached.
- The LCD screen indicates the selected speed level in the driving profile "Drive":

Display	Information
	Selected speed level = 2

#### Procedure with TEN° LCD module

- The power wheelchair has a programmable number of speed levels (delivery condition = 5 speed levels).
- After selecting the User Menu, submenu "Speed Adjust", the desired speed level can be selected (<1>; <2>, <3> ...).
- The pitch of the audible signal changes once the highest or lowest speed level is reached.
- The LCD screen indicates the selected speed level in the "Drive" display:

Display	Information
	Selected speed level = 2

### 7.7.5 Driving

#### **⚠ WARNING**

##### **Driving on unsuitable surfaces**

Risk of falling or tipping over due to operator error

- ▶ Do not operate the power wheelchair on very smooth surfaces (e.g. icy surfaces) or very rough surfaces (e.g. gravel or rubble).

#### **⚠ WARNING**

##### **Driving on slopes, over obstacles**

Falling, tipping over due to user error

- ▶ Only cross obstacles or negotiate ascents or descents that are within the permitted maximums. For more information, see the section "Technical data" (see page 133).
- ▶ Do not cross over any obstacles while ascending or descending inclines.
- ▶ Avoid embarking and disembarking on inclines and slopes.
- ▶ Do not drive over stairs.

#### **⚠ WARNING**

##### **Longer braking distance**

Risk of falling, tipping over or collision due to operator error

- ▶ Note that the braking distance is much longer on downgrades than on the level.
- ▶ Also reduce speed when driving downhill (e.g. select speed level 1).

#### **INFORMATION**

The control unit of the product switches to a safe mode at elevated temperatures and after driving uphill for extended periods of time, limiting the performance of the product.

The user is able to drive the product out of a hazardous situation at any time. After a short time, the product is fully operational again.

The power wheelchair is controlled by moving the joystick:

- The further the joystick is deflected from the centre position, the faster the power wheelchair will drive in this direction.
- The maximum speed at full deflection of the joystick depends on the selected speed level.
- Releasing the joystick automatically activates the brake function, bringing the power wheelchair to a halt.

The mechanical brakes are activated automatically when the power wheelchair comes to a stop so that it cannot roll.

### 7.7.6 Range

The section "Technical data" contains precise information on the range of the product (see page 133).

The following factors influence the range of the product:

- Battery capacity
- Age of the batteries
- Ambient temperature
- Driving conditions (e.g. terrain profile, surface characteristics, frequently driving over obstacles)
- Charging method
- Type and number of power options
- Overall weight of the wheelchair with selected equipment
- Use of power options
- Body weight of user
- Tyres (air pressure, tyre tread depth)

## 7.7.7 Anti-tipper



The anti-tipper makes driving safer (see fig. 47). With a rear-wheel drive, it prevents the wheelchair from tipping too far backward.

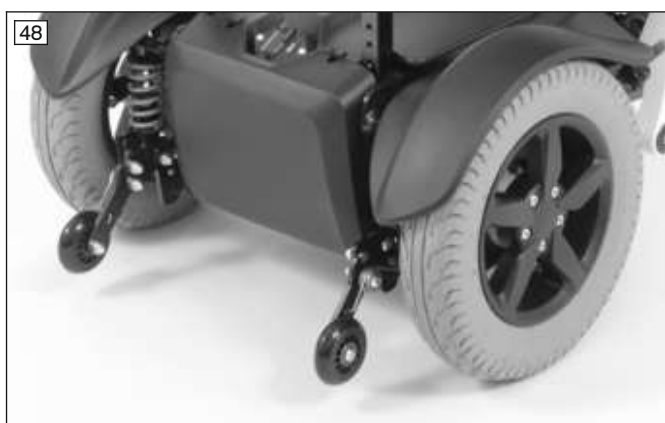

The swing-away, spring-loaded anti-tipper rollers stabilise the front-wheel drive power wheelchair when braking while driving down slopes.

They swing back when driving against a curb, for example.

## 7.7.8 Drive-away lock

### 7.7.8.1 VR2 control unit

#### INFORMATION

This function is currently not enabled.

For questions related to enabling it, please consult the qualified personnel that adapted the product or the manufacturer's service (see inside back cover or back page for addresses).

The power wheelchair control unit features an electronic drive-away lock, which is disabled by default.

If the function has been ordered and enabled, the drive-away lock can be activated or deactivated as follows using the control panel:

#### Activating the drive-away lock

- 1) Press and hold the [On/off] switch while the control unit is turned on.
  - 2) Release the [On/off] button after a beep sounds (approx. 1 second).
  - 3) Push the joystick all the way forward until a beep sounds.
  - 4) Push the joystick all the way back until a beep sounds.
- A long beep confirms that the drive-away lock was activated.  
 → The control unit turns itself off.  
 → A sequential indicator on the [Selected speed level] LED display indicates that the drive-away lock is active:

Display	Information
Sequential indicator on the "Speed levels" LED display	Drive-away lock

#### Deactivating the drive-away lock

When the unit is turned on, the [Charge level] LED display is off and the [Selected speed level] LED indicator is in sequential indicator mode.

- 1) Push the joystick all the way forward until a beep sounds.

- 2) Push the joystick all the way back until a beep sounds.
  - 3) Release the joystick.
- A long beep confirms that the driving function is enabled.  
 → The [Charge level] LED indicator is lit.  
 → The drive-away lock is deactivated and driving is enabled.

### Troubleshooting

The drive-away lock remains active if the deactivation movement is not completed correctly.

- 1) Turn the control device off in order to deactivate the drive-away lock again.
- 2) Turn the power wheelchair on.
- 3) Deactivate the drive-away lock again.

### 7.7.8.2 R-Net control unit

#### INFORMATION

This function is currently not enabled.

For questions related to enabling it, please consult the qualified personnel that adapted the product or the manufacturer's service (see inside back cover or back page for addresses).

The power wheelchair control unit features an electronic drive-away lock. This function is activated/deactivated via the control panel.

#### Activating the drive-away lock

- 1) Press and hold the [On/off] button while the control device is turned on.
  - 2) Release the [On/off] button after a beep sounds (approx. 1 second).
  - 3) Push the joystick all the way forward until a beep sounds.
  - 4) Push the joystick all the way back until a beep sounds.
- A long beep confirms that the drive-away lock was activated.  
 → The control device turns itself off.  
 → A sequential indicator on the [Selected speed level] LED display indicates that the drive-away lock is active:

Display	Information
Sequential indicator on the "Speed levels" LED display	Drive-away lock

#### Deactivating the drive-away lock

- 1) Push the [On/off] button on the control panel.
  - The control device is turned on. The [Selected speed level] LED display is in sequential indicator mode. The [Charge level] LED display is off.
- 2) Push the joystick all the way forward until a beep sounds.
- 3) Push the joystick all the way back until a beep sounds.
- 4) Release the joystick.
  - A long beep confirms that the driving function is enabled.
  - The [Selected speed level] LED display and the [Charge level] LED display are lit up.
  - The drive-away lock is deactivated and driving is enabled.

#### Activating the drive-away lock

- 1) Press and hold the [On/off] button while the control unit is turned on.
  - 2) Release the [On/off] button after a beep sounds (approx. 1 second).
  - 3) Push the joystick all the way forward until a beep sounds.
  - 4) Push the joystick all the way back until a beep sounds.
- A long beep confirms that the drive-away lock was activated.  
 → The control unit turns itself off.  
 → The key symbol on the LCD screen indicates that the drive-away lock is activated:

Symbol	Information
	Drive-away lock

### Deactivating the drive-away lock

- 1) Push the [On/off] button on the control panel.
  - The control unit is turned on. The LCD screen indicates that the drive-away lock is activated.
- 2) Push the joystick all the way forward until a beep sounds.
- 3) Push the joystick all the way back until a beep sounds.
- 4) Release the joystick.
  - A long beep confirms that the driving function is enabled.
  - The battery indicator and speed level are shown on the LCD screen.
  - The drive-away lock is deactivated and driving is enabled.

### Activating the drive-away lock using the TEN° LCD module

The drive-away lock is activated using the [On/Off] button on the TEN° LCD module.

The subsequent procedure is described under "Activating the drive-away lock".

If no joystick is installed, the forward and back movement is carried out using the connected input device.

### Deactivating the drive-away lock using the TEN° LCD module

An information screen is shown on the TEN° LCD module after the power wheelchair is switched on.

The drive-away lock is deactivated using the [On/Off] button on the TEN° LCD module.

The subsequent procedure is described under "Deactivating the drive-away lock".

If no joystick is installed, the forward and back movement is carried out using the connected input device.

### Troubleshooting

The drive-away lock remains active if the deactivation movement is not completed correctly.

- 1) Turn the control device off in order to deactivate the drive-away lock again.
- 2) Turn the power wheelchair on.
- 3) Deactivate the drive-away lock again.

## 7.7.9 Adapting the driving characteristics

### ⚠ WARNING

#### Incorrect configuration of the control device

Falling, tipping over, collision due to incorrect parameter settings

- ▶ The parameter settings of the control device may only be changed by qualified personnel. The manufacturer of the product and the control device manufacturer are not liable in case of damage caused by parameter settings that were incorrectly configured or not adjusted properly according to the user's abilities.

Adjusting and setting the speed, acceleration and deceleration values to the individual user requirements is performed exclusively by the qualified personnel.

## 7.8 Enabling/disabling the brakes

### ⚠ WARNING

#### Uncontrolled rolling away

Risk of collision with persons or nearby objects due to unlocked brakes

- ▶ Note that there is no braking function when the brakes are unlocked. The brake function may only be unlocked in the presence of an attendant.
- ▶ If the user cannot reach the brake release themselves, the brakes can be unlocked by the attendant.
- ▶ Note that when the power wheelchair is moved on an incline, the attendant who is pushing must provide the required brake force.
- ▶ Ensure that the brakes are locked each time when parking the power wheelchair.

**⚠ WARNING****Improper maintenance, repairs or adjustments on the brake**

Falling, tipping, collision with persons or nearby objects due to improper operation

- ▶ Repairs and adjustments on the brakes may only be made by qualified personnel. Incorrect adjustment may lead to a loss of the braking effect.

**⚠ CAUTION****Exposed pinch points**

Crushing, pinching due to incorrect handling

- ▶ Grasp the brake release levers as close to the outer end as possible to avoid pinching your fingers between the splash guard and brake release lever.

**INFORMATION**

The control device outputs a signal on the control panel when the brakes are unlocked. If this is not the case, there is a malfunction that has to be promptly rectified by the qualified personnel.

In case of a control device failure or an insufficient battery charge level, the power wheelchair can be pushed.

To do so, the brakes are deactivated via the mechanical release. The brake releases are located on the right and left of the driving motors.

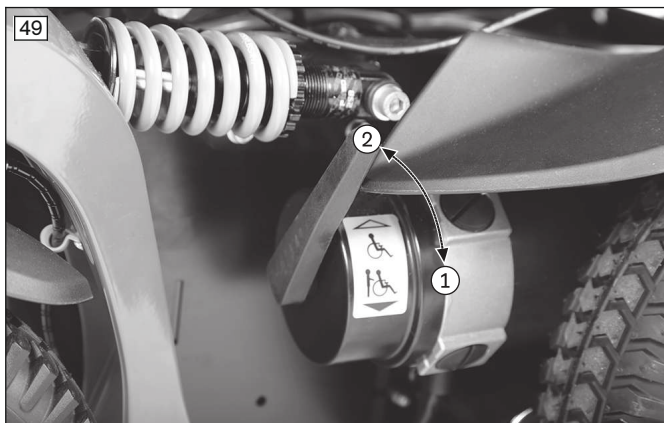
**Releasing/deactivating the brake**

- 1) If needed: Turn the control device off.
- 2) Push the brake release levers down (see fig. 49, item 1).
  - The drive motors are released and the power wheelchair has no braking function.
  - After switching the control device on: The control device recognises that the brake has been released and deactivates the driving function.
  - A warning appears on the control panel.

**Enabling/activating the brake**

- 1) If needed: Turn the control device off.
- 2) Push the brake release lever up (see fig. 49, item 2).
- 3) Switch on the control device.
  - The driving function is activated.

**Releasing/deactivating the brake**

- 1) If needed: Turn the control device off.
- 2) Push the brake release levers down (see fig. 50, item 1).
  - The drive motors are released and the power wheelchair has no braking function.
  - After switching the control device on: The control device recognises that the brake has been released and deactivates the driving function.
  - A warning appears on the control panel.

**Enabling/activating the brake**

- 1) If needed: Turn the control device off.
- 2) Push the brake release lever up (see fig. 50, item 2).
- 3) Switch on the control device.
  - The driving function is activated.

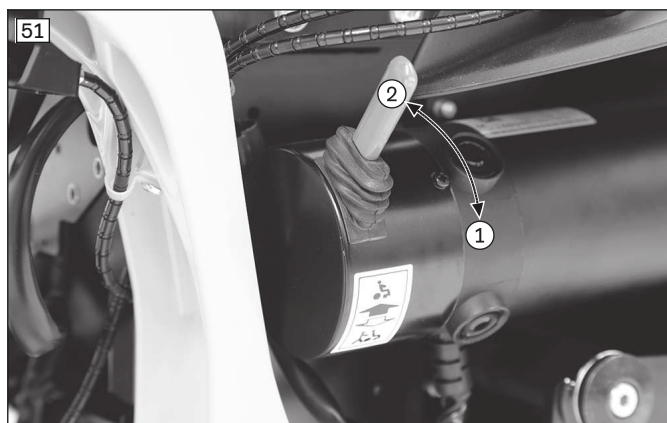

### Releasing/deactivating the brake

- 1) If needed: Turn the control device off.
- 2) Push the brake release levers down (see fig. 51, item 1).
  - The drive motors are released and the power wheelchair has no braking function.
  - After switching the control device on: The control device recognises that the brake has been released and deactivates the driving function.
  - A warning appears on the control panel.

### Enabling/activating the brake

- 1) If needed: Turn the control device off.
- 2) Push the brake release lever up (see fig. 51, item 2).
- 3) Switch on the control device.
  - The driving function is activated.



### Releasing/deactivating the brake

- 1) If needed: Turn the control device off.
- 2) Push the brake release levers down (see fig. 52, item 1).
  - The drive motors are released and the power wheelchair has no braking function.
  - After switching the control device on: The control device recognises that the brake has been released and deactivates the driving function.
  - A warning appears on the control panel.

### Enabling/activating the brake

- 1) If needed: Turn the control device off.
- 2) Push the brake release lever up (see fig. 52, item 2).
- 3) Switch on the control device.
  - The driving function is activated.

### Brake deactivated: warning on control panel

Display	Information
 <p>Flashing light</p>	Brake released

### Brake deactivated: warning on TEN° control panel or TEN° LCD module

Display	Information
	Brake unlocked

## 7.9 Batteries/charging process

### 7.9.1 Safety instructions

#### ⚠ CAUTION

##### Failure to check the charge level before putting into operation

Injury to the user due to stopping suddenly, problems due to unplanned stalling

- ▶ Check the charge level of the batteries before each use.
- ▶ Always make sure that the charge level of the batteries is sufficient for the planned distance.
- ▶ Never drive with the batteries almost fully discharged.
- ▶ When the batteries are almost fully discharged, charge them promptly.

#### NOTICE

##### Unauthorised battery replacement

Battery damage due to improper changes to the product

- ▶ Battery replacement may only be performed by the qualified personnel.
- ▶ The charging profile of the battery charger established at the factory matches the batteries included in the scope of delivery and may not be altered independently.

### 7.9.2 General

#### INFORMATION

- ▶ Please note that Ottobock has delivered this power wheelchair without batteries as per the order.
- ▶ Please note that batteries have been installed in your power wheelchair which are not included in Ottobock's modular system. Ottobock assumes no liability for combinations with accessories from other manufacturers not included in Ottobock's modular system.
- ▶ Prior to using this accessory, please read and observe the instructions for use / manufacturer's instructions from the other manufacturer. These are included with the instructions for use.
- ▶ In case of questions or problems with these accessories, please contact the qualified personnel who adjusted this product.

The power wheelchair is equipped with maintenance-free batteries. See the section "Technical data" for the battery capacity.

The batteries are located under the seat of the power wheelchair, beneath the battery cover.

Prolonged driving when the battery is low results in deep discharge and battery damage. Shortly before, the driving speed decreases and the user is warned regarding battery deep discharge (see page 126).

### 7.9.3 Battery charging information

Batteries may only reach their full capacity after **approx. 20** charging cycles. Only if the full capacity of the batteries has been reached can the power wheelchair achieve the stated driving distance range.

At temperatures of **< 0 °C/32 °F** the battery capacity drops by up to **35 per cent** in relation to the capacity for an outside temperature of **20 °C/68 °F**. This shortens the driving distance range of the power wheelchair accordingly. Moreover, the charge level displayed on the control panel can differ from the actual rated battery capacity to a greater extent.

The following information should be observed for an optimal charging cycle:

- The batteries can be charged at any time, regardless of the remaining charge level.
- It takes about **10 to 12 hours** until a discharged battery (only 1 flashing segment) is fully charged. When the charging process is complete, the battery charger can remain connected to the power wheelchair with no risk of overcharging or damaging the battery. The battery charger features a programmed recharging phase that will maintain the battery capacity at the level that has been reached.
- If the power wheelchair is used every day, the battery should be charged every night.
- Never discharge the batteries completely (deep discharge).
- The batteries will gradually discharge if the wheelchair is not used for extended periods of time. If the power wheelchair is not used for an extended period, the batteries should be charged **1 x per week** to maintain their capacity.



- After charging the batteries, the circuit breaker should be deactivated if the wheelchair is not used for more than 3 days.
- The power wheelchair control device must be switched off while the batteries are charging to allow all of the charging current to be fed into the battery.

#### 7.9.4 Battery charger

##### INFORMATION

- ▶ Please note that Ottobock has delivered this power wheelchair without a battery charger as per the order.
- ▶ Please note that you have received a battery charger which is not included in Ottobock's modular system. Ottobock assumes no liability for combinations with accessories from other manufacturers not included in Ottobock's modular system.
- ▶ Prior to using this battery charger, please read and observe the instructions for use / manufacturer's instructions from the other manufacturer. These are included with the instructions for use.
- ▶ In case of questions or problems with this accessory, please contact the qualified personnel who adjusted this product.

##### NOTICE

##### Improper handling of the battery charger

Damage to the battery charger, damage to the battery due to user error

- ▶ Only use battery chargers which have been verified and approved for use with the respective batteries.
- ▶ Ensure that the information on the battery charger nameplate matches the country-specific voltage of the respective mains grid.
- ▶ Only use the charger within the specified temperature and humidity limits.
- ▶ Place the battery charger on a level surface.
- ▶ Protect the charger against direct sunlight when it is set up near a window.
- ▶ Avoid overheating of the battery charger.
- ▶ Switch the control device off during the charging process so that all of the charging current is fed into the battery.
- ▶ Avoid dust, dirt and moisture.
- ▶ Only clean the charger with a dry cloth.

The battery charger is designed for maintenance-free and low-maintenance batteries.

Please see the instructions for use supplied with the battery charger for further details on use and on the LED displays.

#### 7.9.5 Charging the batteries

##### ⚠ WARNING

##### Improper handling of the battery charger

Risk of electric shock due to contact with live components

- ▶ Do not touch live electrical components. The battery charger and its cables are live when the charger is on.
- ▶ Do not remove any insulation or protective covers.

##### ⚠ WARNING

##### Improper handling of battery chargers

Risk of injury due to negligence in supervision; damage to the battery charger

- ▶ Battery chargers may be used only by persons who have been instructed in their proper and safe use. The user must have read and understood the corresponding instructions for use.
- ▶ Keep the battery charger out of reach of children.
- ▶ Children and persons with limited cognitive abilities may use battery chargers only under the supervision of a responsible person with the relevant knowledge.

**⚠ WARNING****Discharge of explosive gases while charging the battery**

Burns due to explosion after a user error

- ▶ Ensure sufficient ventilation in enclosed rooms.
- ▶ Do not smoke or light a fire.
- ▶ Sparks must be avoided. Switch the battery charger off and disconnect the mains plug before you disconnect the battery.
- ▶ Do not cover the air vents in the trim.
- ▶ Only use battery chargers that have been verified and approved by the manufacturer for use with the respective batteries (observe information on the battery charger). Failure to comply can result in a battery explosion and subsequent health hazards.

**⚠ WARNING****Insufficient ventilation of the battery charger while charging**

Burns due to the battery charger overheating/catching fire

- ▶ Make sure the battery charger cannot overheat during the charging process.
- ▶ Ensure that the cooling fins/ventilation slots on the back of the device are not covered.

**NOTICE****Improper charging**

Damage to the battery due to user error

- ▶ Please note the manufacturer's instructions for the batteries being used. Follow the battery manufacturer safety instructions.
- ▶ Avoid deep discharge of the battery. The manufacturer does not assume any liability for damage due to deep discharge.
- ▶ Charge the battery immediately when the control panel indicates a deep discharge (see section "Buttons and display functions").

**INFORMATION**

Charge the batteries of the power wheelchair for a longer time (over the course of 15 to 20 hours) once a week to increase the battery service life.

**INFORMATION**

Further information on charging the battery with the charging receptacle mounted under the tray when a mid-tray control device is installed: see page 92.

53

**Charging process via the control panel**

- 1) Turn the control unit on the power wheelchair off.
- 2) Plug the battery charger plug into the charging receptacle on the power wheelchair control panel.  
**INFORMATION: Please note that charging via the charging receptacle on the control panel may only be carried out at a current of maximum 10 A.**
- 3) Connect the battery charger to the mains socket.  
→ The charging process starts automatically, and the battery charge condition is indicated by the LED indicator on the control panel and on the battery charger.
- 4) Turn the battery charger off and pull the plug out of the mains socket when the charging process is complete.
- 5) Disconnect the charging plug from the control panel.



- 6) Turn the power wheelchair control unit on. The power wheelchair is ready to use.

#### Charging process via the control panel

- 1) Turn the control unit on the power wheelchair off.
- 2) Plug the battery charger plug into the charging receptacle on the power wheelchair control panel.  
**INFORMATION: Please note that charging via the charging receptacle on the control panel may only be carried out at a current of maximum 10 A.**
- 3) Connect the battery charger to the mains socket.  
→ The charging process starts automatically and the battery charge level is indicated by the LCD screen on the control panel and on the battery charger.
- 4) Turn the battery charger off and pull the plug out of the mains socket when the charging process is complete.
- 5) Disconnect the battery charger plug from the control panel.
- 6) Turn the power wheelchair control unit on. The power wheelchair is ready to use.



#### Charging process via the control panel

- 1) Turn the control unit on the power wheelchair off.
- 2) Plug the battery charger plug into the charging receptacle on the power wheelchair control panel.  
**INFORMATION: Please note that charging via the charging receptacle on the control panel may only be carried out at a current of maximum 10 A.**
- 3) Connect the battery charger to the mains socket.  
→ The charging process starts automatically and the battery charge level is indicated by the LCD screen on the control panel and on the battery charger.
- 4) Turn the battery charger off and pull the plug out of the mains socket when the charging process is complete.
- 5) Disconnect the battery charger plug from the control panel.
- 6) Turn the power wheelchair control unit on. The power wheelchair is ready to use.



### Charging process via the external charging receptacle

- 1) Turn the control device on the power wheelchair off.
- 2) Open the charging receptacle (see fig. 56).
- 3) Plug the battery charger plug into the charging receptacle.

**INFORMATION: Please note that charging via the external charging receptacle may be carried out at a current of up to 12 A.**

- 4) Connect the battery charger to the mains socket.
  - The charging process starts automatically and the battery charge level is indicated by the LCD screen on the control panel and on the battery charger.
- 5) Turn the battery charger off and pull the plug out of the mains socket when the charging process is complete.
- 6) Disconnect the battery charger plug from the charging receptacle.
- 7) Close the charging receptacle (see fig. 56).
- 8) Turn the power wheelchair control device on. The power wheelchair is ready to use.

## 7.10 Seat

### 7.10.1 Safety instructions

#### **⚠ WARNING**

#### **Seat cushions and back support pads may ignite**

Burns due to user error

- ▶ The seat and back support upholstery as well as seat cushions, padding and covers fulfil the normative requirements for flame resistance. However, they may still ignite if fire is handled improperly or negligently.
- ▶ Keep away from all ignition sources, especially lit cigarettes.

#### **NOTICE**

#### **Improper use**

Damage to the seat surface due to user error

- ▶ Do not allow the seat to come into contact with sharp objects. This also applies to animals such as pet cats with sharp claws.
- ▶ If the seat is expected to come into contact with liquid, such as spilt drinks or episodes of incontinence, always use it in conjunction with a liquid-repellent cover.
- ▶ Only use the Ottobock incontinence covers for this product. Contact the qualified personnel to obtain a spare Ottobock cover.

### 7.10.2 Seat type

The product is equipped with a standard seat.



The product is equipped with a VAS seat (Variable Adjust Seat).

This seat type allows the technician to vary the seat depth, seat and back width and centre of gravity settings.

### 7.10.3 Contoured pads

The contoured pads provide the user with good lateral support.



The contoured pads are offered in the flat contoured and deep contoured versions. The pads can also be covered in either cloth or artificial leather.

An incontinence cover is available in addition.

Illustrated: Contoured pads in the version with cloth cover, deep contoured.

#### 7.10.3.1 Detaching/attaching the covers

##### Cloth/artificial leather cover

Before putting on the incontinence cover, the cloth and artificial leather covers have to be taken off the seat pad. In addition, the cloth cover can be taken off the seat and back pads for general cleaning.



##### Taking off/putting on the cover

- 1) Pull the seat or back pad off the hook-and-loop strap.
- 2) Open the zipper of the cover and remove the foam pad.
- 3) Now the cover can be taken off.
- 4) To put on the cover, insert the foam pad into the cover again with proper alignment.
- 5) Close the zipper and secure the seat or back pad again on the hook-and-loop strap.

##### Incontinence cover

###### INFORMATION

Since the artificial leather cover is relatively tight, the incontinence cover is used with the cloth cover as a rule. Nevertheless, you should take the artificial leather cover off from time to time and check whether liquid has gotten into the foam pad through the seams. You should clean the foam pad if this is the case.

The incontinence cover is positioned under the seat cover. It protects the foam pad against wetness.



### Putting on the cover

- 1) Remove the cover.
- 2) Slide the foam pad into the incontinence cover (top left).
- 3) Pull the open end of the incontinence cover up and lay it onto the foam pad (top right).
- 4) Pull the overhanging end of the incontinence cover down and close it on the underside of the foam pad (bottom).
- 5) Put on the cover.

## 7.10.3.2 Cleaning the covers

### Cleaning the cloth cover

#### INFORMATION

- ▶ Replace the cover when it shows signs of advanced wear and tear.
- ▶ To disinfect the cover, add a standard hygiene detergent during washing.
- ▶ Use an additional incontinence cover in case of heavy incontinence. Observe the care and cleaning instructions for the incontinence cover.

- 1) Close the zipper on the cover before washing.
- 2) Wash the cover at 60 °C [140 °F] using a mild, environmentally friendly detergent.  
**Recommendation:** Wash the cover using the delicate cycle at 40 °C [104 °F] to prevent excessive wear.
- 3) Allow to air dry. Do not use a clothes drier.

### Cleaning the artificial leather cover

The artificial leather cover does not have to be removed for cleaning.

- 1) Wipe the artificial leather cover by hand using a damp cloth and mild, environmentally friendly detergent. Do not wash in the washing machine.
- 2) Allow to air dry. Do not use a clothes drier.
- 3) **As needed:** For disinfection, wipe damp with a water-based disinfectant.

### Cleaning the foam pads

- 1) Hand wash all foam components in warm water at 40 °C [104 °F] using a standard mild detergent. Do not use fabric softener. Rinse thoroughly.
- 2) Allow to air dry. Do not expose to direct heat sources (e.g. sunlight, stove or radiator).

## 7.10.4 Back upholstery

#### INFORMATION

- ▶ Please note that Ottobock has delivered this power wheelchair without back upholstery as per the order.
- ▶ Please note that you have received a back system or back upholstery which are not included in Ottobock's modular system. Ottobock assumes no liability for combinations with accessories from other manufacturers not included in Ottobock's modular system.
- ▶ Prior to using the backrest / back upholstery, please read and observe the instructions for use / manufacturer's instructions from the other manufacturer. These are included with the instructions for use.
- ▶ In case of questions or problems with these accessories, please contact the qualified personnel who adjusted this product.

The backrest is equipped with back upholstery.

The qualified personnel can adjust the backrest upholstery in segments to the needs of the user.

## 7.10.5 ADI back support (Baxx line)

The power wheelchair is equipped with an ADI back support (Baxx line).

61



With an anatomically shaped rigid back plate made of aluminium, the back system enables the best possible positioning.

Large openings in the back shells provide for a low weight and easy handling.

Detailed information regarding use, cleaning and maintenance can be found in the included instructions for use.

### 7.10.6 Seat cushion

#### INFORMATION

- ▶ Please note that Ottobock has delivered this power wheelchair without a seat cushion as per the order.
- ▶ Please note that you have received a seat cushion or seating system that is not included in Ottobock's modular system. Ottobock assumes no liability for combinations with accessories from other manufacturers not included in Ottobock's modular system.
- ▶ Prior to using the seat cushion or seating system, please read and observe the instructions for use / manufacturer's instructions from the other manufacturer. These are included with the instructions for use.
- ▶ In case of questions or problems with this accessory, please contact the qualified personnel who adjusted this product.

This power wheelchair was ordered and delivered with a seat cushion.

Wheelchair seat cushions are used for pressure redistribution while sitting. Depending on the version, the seat cushion contains a resilient foam base and possibly additional gel or air-filled inserts. The foam base is anatomically shaped in some cases.

The covers and breathable materials reduce shear forces and ensure a high level of seating comfort for the user.

The seat cushion can be removed for cleaning. Following cleaning, the seat cushion is secured to the seat by a hook-and-loop fastener to prevent sliding.

Detailed information regarding use, cleaning and maintenance can be found in the enclosed instructions for use for the seat cushion.

### 7.10.7 Recaro® seat

The Recaro® seat provides individually adjustable, comprehensive seating comfort.

#### 7.10.7.1 Settings

62



#### Adjusting the back support angle

- 1) Turn the knob on the right or left side of the back support (see fig. 62, item 1).
- 2) Change the back support angle to the desired position (see fig. 62, item 2).

**CAUTION! Note that the maximum back support angle is 30° while stationary and 20° while driving.**



### Adjusting the lateral supports in the lumbar region

#### 1) **INFORMATION: This information only applies to the Recaro® LT model.**

Turn the handwheel on the side of the back support forward (see fig. 63, item 1).

→ Both lateral supports evenly move closer together.

#### 2) Turn the handwheel on the side of the back support backward (see fig. 63, item 1).

→ The two lateral supports are moved further apart.

### Adjusting the pads

The seat surfaces X and W are equipped with a pull-out pad at the front of the seat bottom. The adjustment lever for the pad is located below the seat bottom.

- 1) Pull the pad adjustment lever up and hold it there.
- 2) Move the pad to the desired position.
- 3) Release the adjustment lever and let it engage. The adjustment lever is in a safe position if it engages audibly and has returned to its initial position.

### Adjusting the headrest

The height and tilt angle of the headrest are adjustable.

#### 7.10.7.2 Use



### Folding down the back support (reducing the transport size)

- 1) Pull the release lever up (see fig. 64, item 1).
- 2) Fold the back support forward or back (see fig. 64, item 2).
- 3) Let go of the release lever.



### Remove the headrest

Two persons are required to remove the headrest.

- 1) 1st person: Find the release points on the Recaro® seat below the cover and push on them both at the same time.
- 2) 2nd person: Pull the headrest up and remove.



## 7.10.8 Mounting kit for head/neckrests



The mounting kit is used to install head/neckrests. It is mounted to the back frame by means of an adapter. Detailed information regarding use, maintenance and repair can be found in the included instructions for use.

## 7.10.9 Headrest

The head support or head/neckrest stabilises and guides the user's head. It has been mounted to the mounting kit for head/neckrests by qualified personnel.

Detailed information regarding use, maintenance and repair can be found in the included instructions for use.

## 7.11 Power seat functions

### 7.11.1 Safety instructions

#### **⚠ WARNING**

##### **Driving with power seat functions**

Falling, tipping over due to driving with unallowable seat settings

- ▶ Only drive in road traffic and on inclines and downgrades with the seat tilt and seat height adjustments lowered and with a vertical backrest. Always use a belt system.
- ▶ Slightly tilt the seat to the rear when driving down obstacles in a forward direction (e.g. curbs) and reduce the speed.
- ▶ Drive with the seat raised or with the seat tilt/back angle adjustment activated only for short distances at home. Always use the speed level 1 for this. Note that the field of vision is limited when driving. Always use a belt system.
- ▶ Use the seat height adjustment and the seat tilt only on firm, level ground.
- ▶ To avoid uncontrolled driving movements, ensure that the control unit is always in "Power seat functions" mode before using the power seat functions.
- ▶ To avoid hazardous situations, note the correct deflection direction of the joystick (see page 80).

#### **⚠ WARNING**

##### **Overloading**

Risk of falling, tipping over due to non-compliance with technical data

- ▶ Note that the maximum permitted load of the power wheelchair may be reduced when using power seat functions (see the section "Technical data").

#### **⚠ WARNING**

##### **Exposed pinch points**

Pinching, crushing of limbs (e.g. fingers) due to lack of caution in danger areas, damage to the product

- ▶ Note that when seat functions are used, inherent pinch and shear points are located between the seat frame and the power wheelchair frame.
- ▶ Ensure that no body parts, such as hands or feet, are in the danger area while the seat functions are used.
- ▶ Ensure that no interfering objects, such as clothing or other obstacles, are in the danger area while the seat functions are used.

**⚠ WARNING**

**Overloading of the actuators**  
 Risk of falling, tipping, pinching, crushing of limbs due to improper handling

- ▶ Avoid overloading the actuators. Overloading may cause components to break, leading to uncontrolled dropping of the seat or causing the backrest to flip back.

**⚠ WARNING**

**Lack of maintenance**  
 Severe user injuries, damage to the product due to maintenance errors

- ▶ Check the adjustment functions for visible signs of damage at least **1 x per month** and ensure all screw connections are tight.

**NOTICE**

**Improper use of electric seat options**  
 Damage to the product through user error

- ▶ When using electric seat options, note that the seat function actuators are not designed for continuous use, only for short-term use under limited loads (10% load, 90% idle time).
- ▶ Observe the following guidelines: at maximum load capacity, 10 seconds of activation time must be followed by approx. 90 seconds of idle time. The power seat functions are considered independently of the driving function for this purpose.
- ▶ Only activate the power seat functions if no fault or error is present.

**7.11.2 Speed reduction**

Depending on the configuration, using a seat adjustment may lead to a speed reduction.

When speed reduction is active, this is indicated on the control panel as follows:

**VR 2 control device**

Display	Information
	Restricted speed (creep speed) <b>The [Selected speed level] LED display flashes:</b> Automatic speed reduction (e.g. because a seat function was activated)

**R-Net control device – JSM-LED-L control panel**

Display	Information
	Restricted speed (creep speed) <b>The [Selected speed level] LED display flashes:</b> Automatic speed reduction (e.g. because a seat function was activated)

**R-Net control device – TEN° control panel; TEN° LCD module**

Display	Information
	Restricted speed (creep speed) <b>Turtle symbol lights up yellow:</b> automatic speed reduction (e.g. because a seat function was activated)

**7.11.3 Power seat height adjustment**

**⚠ WARNING**

**Incorrect handling of the seat height adjustment**  
 Falling, tipping over due to driving with improper seat settings

- ▶ Only use the seat height adjustment with the back support angle set to vertical.
- ▶ Drive in street traffic only with the seat height adjustment lowered.
- ▶ Even when driving indoors, fasten the belts and do not lean out beyond the seat surface when the seat height adjustment feature is raised.
- ▶ Ensure that creep speed is activated when the seat height adjustment function is used. If this is not the case, contact the qualified personnel immediately. Only use the power wheelchair with the seat height adjustment in its lowest position until the fault is rectified.

**NOTICE****Risk of transportation damage**

Damage to the product through user error

- ▶ Always lower the seat height adjustment feature fully for loading or transportation.

**INFORMATION**

- ▶ Please also observe the generally applicable safety instructions in the section "Power seat functions" > "Safety instructions" (see page 73).
- ▶ Observe the instructions for use in the sections "Controlling power seat functions" (see page 79) and "Joystick functions" (see page 80).

67



The power seat height adjustment feature raises the seat by **350 mm (13.8")** using a motor drive.

The seat can be moved up continuously to the height specified.

The driving function can be used indoors even when the seat is raised. The speed is decreased when the seat is raised (see previous section).

68



The power seat height adjustment feature raises the seat by **350 mm (13.8")** using a motor drive.

The seat can be moved up continuously to the height specified.

The driving function can be used indoors even when the seat is raised. The speed is decreased when the seat is raised (see previous section).

**7.11.4 Power seat tilt****⚠ WARNING****Incorrect seat tilt handling**

Falling, tipping over due to driving with unallowable seat settings

- ▶ Use the seat tilt feature only with the backrest in the upright position.
- ▶ Drive in street traffic only with the seat tilt lowered.
- ▶ When driving with the seat tilt activated, even at home, fasten the belts and do not lean out beyond the seat surface.

**NOTICE****Improper use of the seat tilt**

Damage to the seat back due to collision with the luggage carrier

- ▶ Note that the seat back may collide with the luggage carrier when the seat is fully tilted. In this case, remove the luggage carrier before using the seat tilt.
- ▶ Note that the seat back may collide with items on the luggage carrier even when the seat is only tilted slightly. Take the items off the luggage carrier in this case. If this is not possible, then the seat must not be adjusted too far back.

**INFORMATION**

- ▶ Please also observe the generally applicable safety instructions in the section "Power seat functions" > "Safety instructions" (see page 73).
- ▶ Observe the instructions for use in the sections "Controlling power seat functions" (see page 79) and "Joystick functions" (see page 80).

69



The power seat tilt function allows the seat to be tilted by up to **45°**, for example to relieve pressure (with centre of gravity shift).

The seat can be tilted back continuously to the specified angle.

70



The power seat tilt function allows the seat to be tilted by up to **45°**, for example to relieve pressure (with centre of gravity shift).

The seat can be tilted back continuously to the specified angle.

**7.11.5 Combined seat height adjustment/seat tilt**

This function allows the seat to be tilted while continuously raising the seat surface at the same time.

For further information on the functions and relevant safety information, see the preceding section.

**7.11.6 Power back angle adjustment****⚠ WARNING****Incorrect use of back angle adjustment**

Falling, tipping over due to driving with unallowable seat settings

- ▶ Drive in street traffic only with a vertical backrest.
- ▶ When driving with the back angle adjustment activated, even at home, fasten the belts and do not lean out beyond the seat surface.

**NOTICE****Improper use of the back angle adjustment**

Damage to the seat back due to collision with the luggage carrier

- ▶ Note that the seat back may collide with the luggage carrier when the back support is fully tilted. In this case, remove the luggage carrier before using the back angle adjustment.
- ▶ Note that the seat back may collide with items on the luggage carrier even when the back support is only tilted slightly. Take the items off the luggage carrier in this case. If this is not possible, then the back support must not be adjusted too far back.

**INFORMATION**

- ▶ Please also observe the generally applicable safety instructions in the section "Power seat functions" > "Safety instructions" (see page 73).
- ▶ Observe the instructions for use in the sections "Controlling power seat functions" (see page 79) and "Joystick functions" (see page 80).

71



The power back angle adjustment feature enables the backrest to be tilted up to **30°**.

The backrest can be tilted back continuously to the angle specified.

72



The power back angle adjustment feature enables the backrest to be tilted up to **30°**.

The backrest can be tilted back continuously to the angle specified.

**7.11.7 Power legrests****⚠ WARNING****Incorrect use of the power leg supports**

Falling, tipping over due to driving with unallowable seat settings

- ▶ Drive in street traffic only with the leg supports lowered.

**INFORMATION**

- ▶ Please also observe the generally applicable safety instructions in the section "Power seat functions" > "Safety instructions" (see page 73).
- ▶ Observe the instructions for use in the sections "Controlling power seat functions" (see page 79) and "Joystick functions" (see page 80).

73



The legrests prevent a constant pressure load or provide anti-shock support.  
The legrests can be operated individually or at the same time, depending on the configuration.

74



The footrests can be flipped up to increase the entry and exit area.  
In addition, the electrically adjustable legrests can be lifted up and out of their brackets (item 1).

75



The legrests prevent a constant pressure load or provide anti-shock support.  
The legrests can be operated individually or at the same time, depending on the configuration.

76



The footrests can be flipped up to increase the entry and exit area.  
In addition, the electrically adjustable legrests can be lifted up and out of their brackets (item 1).

### 7.11.8 Controlling power seat functions

#### INFORMATION

If your power wheelchair is equipped with a TEN° LCD module, please also read the corresponding section: see page 37.

#### INFORMATION

If your power wheelchair is equipped with a push-button module, you can select and control the power seat functions directly (see page 90).

#### 7.11.8.1 VR2 control unit

- Power seat functions are activated and controlled via the control panel (see page 31 et seq.).
- The driving function is not available during the activation of a seat function, and the [Selected speed level] LED display turns off.
- A seat function is activated by pressing the [Select additional power options] button. This button toggles through the functions in the order 'Seat function 1' > 'Seat function 2' > 'No seat function'.
- The LED display for the activated seat function lights up when that function is activated. The driving function is not available at this time, and the [Selected speed level] LED display turns off.
- Once a seat function is selected, it is operated by moving the joystick forward or backward.
- The electric motor moves the seat according to the seat function as long as the joystick is deflected and stops at the end positions.
- Press the [Select additional power options] button again to deactivate the seat function after adjusting it. The driving function is available again, and the [Selected speed level] LED display is lit again.

#### 7.11.8.2 R-Net control unit

- If the power wheelchair is equipped with one or more power seat functions, they are activated and controlled via the control panel (see page 33 ff.).
- The "Power seat functions" mode is accessed by pressing the [Mode] button. The [Selected seat function] LED display lights up. The first seat function that can be controlled, established in the programming, is displayed (see the following section "Joystick functions").  
**Please note:** Depending on programming, the [Mode] button may need to be pressed a number of times before the [Selected seat function] LED display lights up.
- Moving the joystick to the left/right switches between the seat functions. The [Selected seat function] LED display indicates the currently selected seat function (see the following section "Joystick functions"). The driving function is not available at this time, and the [Selected speed level] LED display turns off.
- Once a seat function is activated, it is adjusted by moving the joystick forward or backward.
- The electric motor adjusts the seat function as long as the joystick is deflected, and stops at the end positions.
- Exit the "Power seat functions" mode by pressing the [Mode] button again. You can now toggle through the driving function or other modes (depending on the programming).  
**Please note:** The driving function is available again when the [Selected speed level] LED display is lit.

#### Procedure when using the TEN° control panel

- Activate the "Seating" mode by pressing the [Profile/Mode] button (see page 79 ff.). The LCD screen indicates the selected mode (see the following section "Joystick functions"). Depending on programming, the [Profile/Mode] button may need to be pressed a number of times.
- Moving the joystick to the left/right switches between the seat functions in "Seating" mode. The LCD screen indicates the currently selected seat function (see the following section "Joystick functions"). The driving function is not available at this time and the speed level indicator switches off.
- Once a seat function is activated, it is adjusted by moving the joystick forward or backward.
- The electric motor moves the seat according to the seat function as long as the joystick is deflected and stops at the end positions.
- Exit the "Seating" mode by pressing the [Profile/Mode] button again. You can now toggle through the driving function or other modes (e.g. Bluetooth mode).

### Procedure when using the TEN° LCD module

- Activate the "Seating" mode by pressing the [Mode] button (see page 79 ff.). The LCD screen indicates the selected mode (see the following section). Depending on programming, the [Mode] button may need to be pressed a number of times.
- In "Seating" mode, switch between the seat functions with a movement to the left/right using the respective installed input device (e.g. joystick, navigation buttons on the TEN° LCD module, special control input devices). The LCD screen indicates the currently selected seat function (see the following section). The driving function is not available at this time and the speed level indicator switches off.
- Once a seat function is activated, the respective seat function is adjusted with a forward/backward movement of the respective input device (e.g. joystick, navigation buttons on the TEN° LCD module, special control input devices).
- The electric motor moves the seat according to the seat function as long as the input device is operated and stops at the end positions.
- Exit the "Seating" mode by pressing the [Mode] button again. You can now toggle through the driving function or other modes (e.g. Bluetooth mode).

### 7.11.9 Joystick functions





The following power seat functions can be controlled with the joystick:

#### VR2 control device

Function	Joystick deflection (standard setting) <sup>1)</sup>
Seat height adjustment	Back: Seat surface moves up Forward: Seat surface moves down
Seat tilt	Back: Seat slowly tips back Forward: Seat slowly tips forward to a horizontal position
Back support angle adjustment	Back: Back support tilts backward Forward: Back support tilts forward
Leg supports	Back: Both leg supports move up Forward: Both leg supports move down

<sup>1)</sup> Direction of movement can be modified by the qualified personnel.

#### R-Net control device – JSM-LED-L control panel

JSM display	Function	Joystick deflection (standard setting) <sup>1)</sup>
	Power seat tilt	Back: Seat slowly tips back Forward: Seat slowly tips forward to a horizontal position
	Power back angle adjustment	Forward: Back support tilts forward Back: Back support tilts backward
	Power seat height adjustment	Forward: Seat surface moves up Back: Seat surface moves down
	Power foot supports - left	Forward: left foot support moves forward Back: Left foot support moves back
	Power foot supports - right	Forward: Right foot support moves forward Back: Right foot support moves back







JSM display	Function	Joystick deflection (standard setting) <sup>1)</sup>
	Power foot supports, coupled	Forward: Both foot supports move forward Back: Both foot supports move back

<sup>1)</sup> Direction of movement can be modified by the specialist dealer.

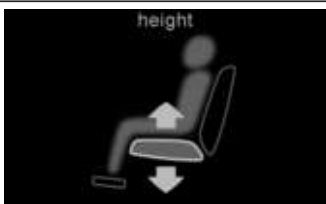
The following power seat functions can be controlled with the input device (e.g. joystick):

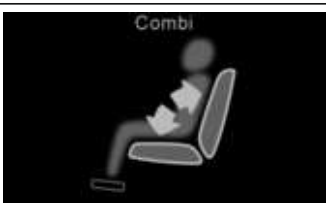
### “Seating” mode

Display	Function	Deflection using the input device <sup>1)</sup>
	“Seating” mode start screen This mode enables operation of the power seat functions delivered with the power wheelchair.	Right: Calls up a power seat function* Left: Calls up a power seat function* * Consecutively, depending on order
	Power seat height adjustment	Back: Seat surface moves up Forward: Seat surface moves down
	Power seat tilt	Back: Seat slowly tips back Forward: Seat slowly tips forward to a horizontal position
	Power back support angle adjustment	Back: Back support tilts backward Forward: Back support tilts forward
	Combined seat height adjustment and seat tilt	Forward: Seat functions move forward Back: Seat functions move back
	Power leg support left	Back: The left leg support moves up Forward: The left leg support moves down
	Power leg support right	Back: The right leg support moves up Forward: The right leg support moves down

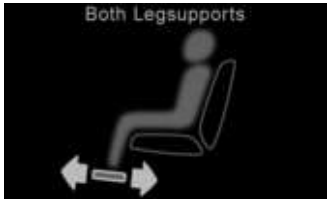
Display	Function	Deflection using the input device <sup>1)</sup>
	Power leg supports, coupled	Back: Both leg supports move up Forward: Both leg supports move down

<sup>1)</sup> Direction of movement can be modified by the qualified personnel.

## 7.12 Manual seat functions

### 7.12.1 Safety instructions

#### ⚠ WARNING

##### Lack of maintenance

Severe user injuries, damage to the product due to maintenance errors

- ▶ Check the adjustment functions for visible signs of damage at least **1 x per month** and ensure all screw connections are tight.

### 7.12.2 Manually elevating legrests

#### INFORMATION

- ▶ Please also observe the overriding safety instructions in the section "Manual seat functions" > "Safety instructions": see page 82.

The mechanically elevating legrests with a gas compression spring let the user change the angle independently to prevent a constant pressure load or to provide anti-shock support.



#### Pivoting the leg support

- 1) Activate the release lever on the leg support (see arrow).
  - 2) Move the leg support to the desired position.
  - 3) Let go of the release lever.
- The leg support is adjusted.

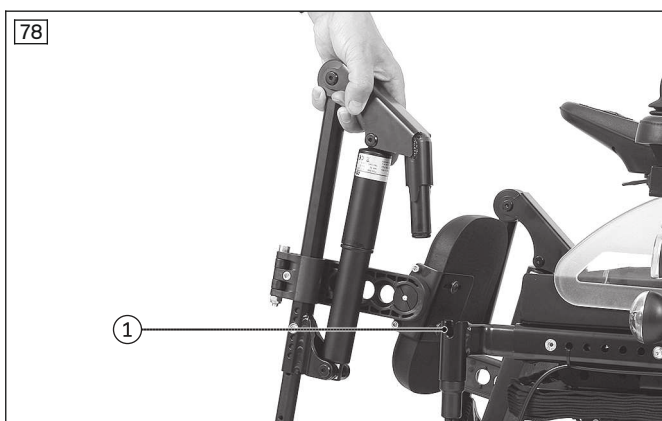

#### Removing the leg support

- 1) Grasp the top of the leg support (see fig. 78, item 1).
- 2) Pull the leg support straight up and out of the holder.

#### Attaching the leg support

- 1) Grasp the top of the leg support (see fig. 78, item 1).
  - 2) Push the leg support straight down into the holder.
- The foot supports can also be folded up to increase the entry and exit area.

## 7.13 Lap belt

The positioning belt (lap belt) prevents the user from sliding out of the seat.

### 7.13.1 Adaptation

#### ⚠ CAUTION

#### Improper adjustments

Injuries, malpositions, illness of the user due to adjustment changes

- ▶ The belt system is an important part of an individual seating unit/seating solution. Do not modify the installation position and basic settings established by the qualified personnel.
- ▶ In case of problems with these adjustments (such as an unsatisfactory sitting position), promptly contact the qualified personnel who fitted the product.
- ▶ **Immediately** consult the qualified personnel if you notice signs of discomfort or fear when using a belt system.
- ▶ Have the basic settings of the belt system checked regularly. Adjustments may be required due to the growth of the user or because of changes in the course of the disease.

Small length adjustments of the belt by the user or an attendant (e.g. for clothing of different thickness) are possible.

The belt length can be adjusted on both sides. Excess belt length is taken up by the plastic slider.

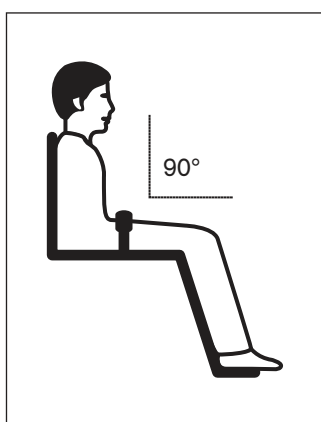
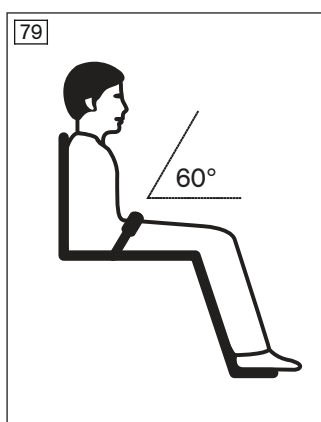

#### Positioning the user in the seat

- Place the user in an upright, 90° seated position (if physiologically possible).
- Ensure that the back is up against the backrest padding (if physiologically possible).
- The lap belt should be at an angle of about 60° to 90° to the seat surface and run in front of the pelvic bone.

#### Possible positioning errors

- The lap belt is positioned above the pelvis of the user in the area of the soft part of the stomach.
- The user does not sit upright in the seat.
- If the lap belt is too loose, the user can shift/slide out to the front.
- During the installation/adjustment, the lap belt is routed over parts of the seating system (e.g. over armrests or seat pads). This causes the lap belt to lose its retaining function.



#### Adjusting the belt length

- 1) Position the user in the seat. Follow the positioning instructions in the previous section to do so.
- 2) Close the belt.
- 3) Position the 2 halves of the buckle in front of the upper body, centred over the thighs.
- 4) Position the respective half of the buckle at a right angle (see fig. 80, item 1).
- 5) Slide the 2 halves of the closure to the desired position.
- 6) Release the respective half of the buckle.
- 7) Verify the adjustment.

**WARNING! The lap belt has to fit closely but not too tightly so the user is not injured. It should be possible to slide two fingers comfortably between the strap and thigh.**

### 7.13.2 Use

#### ⚠ WARNING

##### Incorrect application of the belt

Throttling, suffocation or strangulation due to sliding forwards in the product

- ▶ The positioning belt (lap belt) must be put on after getting into the product and used at all times while using the product.
- ▶ Ensure that the buckle lies in the middle of the body.
- ▶ Remove any objects or clothing which get caught.

#### ⚠ CAUTION

##### Improper use

Falling, user falling out due to improper use

- ▶ Only open the positioning belt (lap belt) when the user is ready to get out of the product.
- ▶ Do not leave the user unsupervised if the cognitive abilities of the user could lead to unintentional opening of the belt.
- ▶ Information about subsequent acquisition and mounting is provided by the qualified personnel that handed the product over to you.

#### ⚠ CAUTION

##### Medical risks

Injuries, pressure sores due to application errors

- ▶ Regular measures for pressure redistribution and skin examinations are required. Should skin irritation and/or skin reddening occur, consult the qualified personnel who adapted and adjusted the product. Do not continue using the product without consultation.



##### Applying the lap belt

> **Prerequisite:** Note the positioning instructions in the previous section.

- 1) Push the 2 halves together until the buckle engages with an audible click.

**WARNING! The lap belt has to fit closely but not too tightly so the user is not injured. It should be possible to slide two fingers comfortably between the strap and thigh.**

- 2) Pull to check that it is secure.

##### Opening the lap belt

- 1) Press the release button.
- 2) Open the belt buckle and lay the belt to the side.

### Cleaning the belt system

#### INFORMATION

Observe the washing recommendations on the product and the information in the corresponding instructions for use provided for the product.

- Straps with metal closures **may not be washed in the washing machine** as the penetration of water could cause corrosion and subsequent malfunctions.
- Clean the belt straps by gently dabbing them with warm soapy water (with some disinfectant) or carefully wipe with a dry, clean, absorbent cloth.

##### Additional cleaning instructions

- Allow the belts to air dry. Ensure that the belts and pads are completely dry before installation.
- Do not expose the belts to direct heat (e.g. sunshine, stove or radiator).
- Do not iron or bleach the belts.

## 7.14 Lap belt with rewriter

The lap belt has a locking mechanism to prevent the user from sliding forward out of the seat.

A rewriter allows the length of the lap belt to be freely adjusted. It tightens automatically according to the user's movements.

### 7.14.1 Adaptation

#### ⚠ CAUTION

##### Improper adjustments

Injuries, malpositions, illness of the user due to adjustment changes

- ▶ The belt system is an important part of an individual seating unit/seating solution. Do not modify the installation position and basic settings established by the qualified personnel.
- ▶ In case of problems with these adjustments (such as an unsatisfactory sitting position), promptly contact the qualified personnel who fitted the product.
- ▶ **Immediately** consult the qualified personnel if you notice signs of discomfort or fear when using a belt system.
- ▶ Have the basic settings of the belt system checked regularly. Adjustments may be required due to the growth of the user or because of changes in the course of the disease.

Length adjustment is not necessary since the belt tightens automatically. Nevertheless, some basic positioning instructions should be observed.

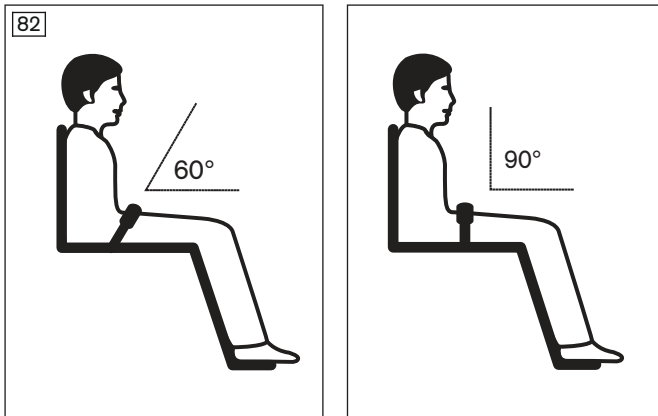

#### Positioning the user in the seat

- Place the user in an upright, 90° seated position (if physiologically possible).
- Ensure that the back is up against the back support pad (if physiologically possible).
- The lap belt should be at an angle of about 60° to 90° to the seat surface and run in front of the hip bone.

#### Possible positioning errors

- The lap belt is positioned above the user's pelvis in the area of the soft tissue of the stomach.
- The user does not sit upright in the seat.
- If the lap belt is too loose, the user can shift/slide out to the front.
- The lap belt is routed over parts of the seating system (e.g. over forearm supports or seat pads) when applied. This causes the lap belt to lose its retaining function.

### 7.14.2 Use

#### ⚠ WARNING

##### Incorrect application of the belt

Throttling, suffocation or strangulation due to sliding forwards in the product

- ▶ The positioning belt (lap belt) must be put on after getting into the product and used at all times while using the product.
- ▶ Ensure that the buckle lies in the middle of the body.
- ▶ Remove any objects or clothing which get caught.

**CAUTION****Improper use**

Falling, user falling out due to improper use

- ▶ Only open the positioning belt (lap belt) when the user is ready to get out of the product.
- ▶ Do not leave the user unsupervised if the cognitive abilities of the user could lead to unintentional opening of the belt.
- ▶ Information about subsequent acquisition and mounting is provided by the qualified personnel that handed the product over to you.

**CAUTION****Improper adjustments**

Injury due to overtightening of the lap belt

- ▶ Automatic tightening of the lap belt may lead to excessive pressure at the contact points of the lap belt.
- ▶ If the lap belt with rewriter fits too snugly, it has to be opened and applied again. Alternatively, the user or an attendant can unlock the belt at the belt reel and loosen it somewhat.

**CAUTION****Medical risks**

Injuries, pressure sores due to application errors

- ▶ Regular measures for pressure redistribution and skin examinations are required. Should skin irritation and/or skin reddening occur, consult the qualified personnel who adapted and adjusted the product. Do not continue using the product without consultation.

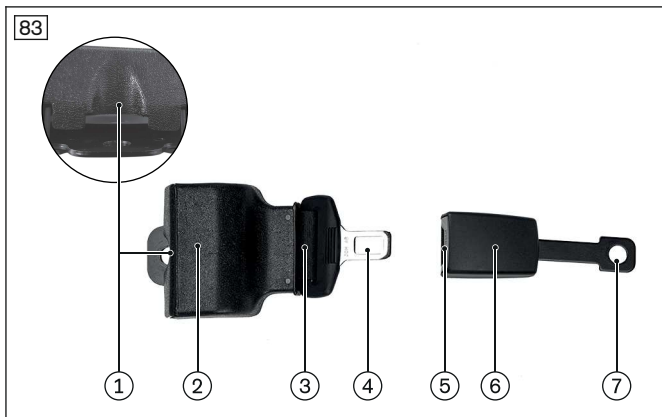
**Alignment**

- 1 Rewinding belt unlocking mechanism
- 2 Rewinding belt housing
- 3 Rewinding belt
- 4 Rewinding belt tongue piece
- 5 Buckle unlocking mechanism
- 6 Buckle
- 7 Buckle mounting point

**Applying the lap belt**

- > **Prerequisite:** Note the positioning instructions in the previous section.
- 1) Hold the rewinding belt (see fig. 83, item 3) by the tongue piece (see fig. 83, item 4) and pass it around the user's body to the buckle (see fig. 83, item 5/6).
- 2) Push the tongue piece into the buckle until you hear the tongue piece click into place (see fig. 84, item 1/2).

**WARNING! The lap belt has to fit closely but not too tightly so the user is not injured. It should be possible to slide two fingers comfortably between the belt and thigh.**

- 3) Pull to check that it is secure.

**Opening the lap belt**

- 1) Push the unlocking mechanism on the buckle (see fig. 84, item 2).

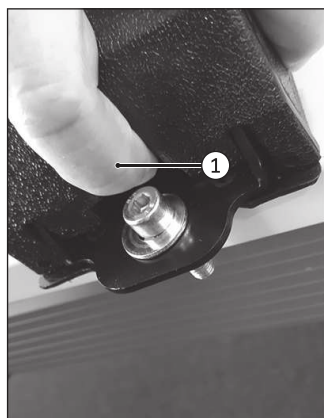

- 2) Open the buckle and pull out the belt (see fig. 84, item 1/2).
- 3) Allow the belt to retract into the belt reel.

#### **If necessary: Loosen the lap belt**

The lap belt can be loosened if it is too tight.

- 1) Apply light to moderate pressure to push in the unlocking mechanism of the rewinding belt (see fig. 85, item 1). To do so, reach into the indentation of the housing and push the housing inward.
- 2) The unlocking mechanism releases the rewinder. Now the lap belt can be unrolled and rewound without resistance.
- 3) Pull the lap belt out slightly.
- 4) Release the housing of the rewinder. The rewinding belt is locked again.

#### **Cleaning the belt system**

- Always dry clean the belt to protect the rewinder against the ingress of water and therefore against corrosion.
- Carefully wipe the belt straps with a clean, dry, absorbent cloth.

#### **Additional cleaning instructions**

- Allow the belts to air dry. Ensure that the belts and pads are completely dry before installation.
- Do not expose the belts to direct heat (e.g. sunshine, stove or radiator).
- Do not iron or bleach the belts.
- Do not expose the belts to direct heat (e.g. sunlight, stove or radiator).
- Do not iron or bleach the straps.

## **7.15 Control unit accessories**

### **7.15.1 Attendant control**

#### **7.15.1.1 VR2 attendant control**

The power wheelchair has been equipped with a separate control panel for attendant operation. The separate control panel is height-adjustable and removable.

#### **Functional overview**

The attendant uses the attendant control to operate the driving function and the power seat functions. The module is connected in conjunction with the control panel or as a separate input device.

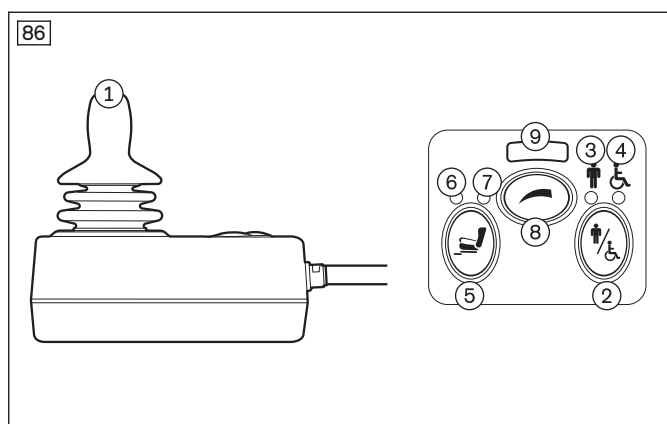

- 1 Joystick
- 2 [Activate/deactivate attendant control] button
- 3 [Attendant control active] LED display (green LED display)
- 4 [Primary control active] LED display (red LED display)
- 5 [Select additional power function] button
- 6 [Seat function 1] LED display
- 7 [Seat function 2] LED display
- 8 [Select speed level] button
- 9 [Selected speed level] LED display

#### **Joystick**

The attendant uses the joystick to control the speed and driving direction. When a seat option is activated, the joystick operates this seat option.

**[Activate/deactivate attendant control] button**

The attendant uses this button to assume the control functions from the control panel or to return them to the control panel. The current state is shown by an LED indicator.

**[Attendant control active] LED display**

The green LED lights up when the attendant control is activated and the power wheelchair control panel is deactivated.

**[Primary control active] LED display**

The red LED lights up when the attendant control is deactivated and the power wheelchair control panel is activated.

**[Select additional power function] button**

Pressing this button selects seat function 1, then seat function 2. The selected seat function is indicated by the LEDs.

Pressing the button one more time returns to driving mode (seat function LED display is not lit).

**[Seat function 1/2] LED display**

This LED display shows the currently active additional power function.

**[Select speed level] button**

Pressing the button increases/decreases the speed level. The acoustic signal changes when the maximum speed level is reached.

**[Selected speed level] LED display**

The LEDs show the currently selected speed level (1-5).

**7.15.1.2 R-Net attendant control**

The power wheelchair has been equipped with a separate control panel for attendant operation. The separate control panel is height-adjustable and removable.

**Functional overview**

The attendant uses the attendant control to operate the driving function and the power seat functions.

The module is connected in conjunction with the control panel or as a separate input device.

The module is connected in combination with the TEN° LCD module and the special control (if any).

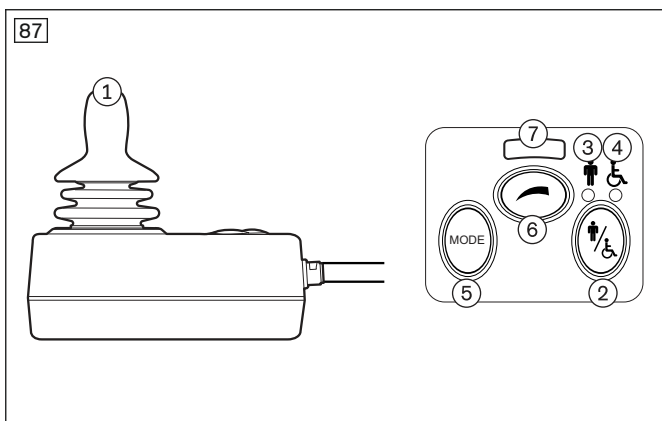

- 1 Joystick
- 2 [Activate/deactivate attendant control] button
- 3 [Attendant control active] LED display (green LED display)
- 4 [Primary control active] LED display (red LED display)
- 5 [Mode] button
- 6 [Select speed level] button
- 7 [Selected speed level] LED display

**Joystick**

The attendant uses the joystick to control the speed and driving direction (see page 58).

When the control device is in a seat mode, the seat option can be extended or retracted by moving the joystick forwards/backwards (see page 79).

**[Activate/deactivate attendant control] button**

The attendant uses this button to assume the control functions from the control panel or special control (if installed). By pressing the button again, the attendant returns the control functions to the control panel or special control. The respective state is shown by an LED indicator.



**[Attendant control active] LED display**

The green LED lights up when the attendant control is activated and the power wheelchair control panel is deactivated.

**[Primary control active] LED display**

The red LED lights up when the attendant control is deactivated and the power wheelchair control panel is activated.

**[Mode] button**

Pressing this button toggles through "seat function 1" > "seat function 2" > "seat function ..." in sequence. The selected seat function is indicated by the LEDs. Pressing the button one more time returns to driving mode (seat function LED display is not lit).

**[Select speed level] button**

Pressing the button increases/decreases the speed level. The acoustic signal changes when the maximum speed level is reached.

**[Selected speed level] LED display**

The LEDs show the currently selected speed level (1–5).

**Joystick**

The joystick controls the speed and driving direction in the "Drive" profile (see page 58).

If the control device is in "Seating" mode, the seat option can be operated by moving the joystick forwards/backwards (see page 79) or switched to the next seat option by moving it left/right.

You can navigate within the operating modes (e.g. "Bluetooth Device") by moving the joystick forwards/backwards or right/left.

**[Activate/deactivate attendant control] button**

The attendant uses this button to assume the control functions from the control panel or TEN° LCD module. By pressing the button again, the attendant returns the control functions to the control panel or special control. The current state is shown by an LED indicator.

After the attendant control has been switched on, the LCD screen shows the following:

Display	Information
	Attendant control active

**[Attendant control active] LED display**

The green LED lights up when the attendant control is activated and the user's control module is deactivated.

**[Primary control active] LED display**

The red LED lights up when the attendant control is deactivated and the user's control module is activated.

**[Mode] button**

Pressing this button toggles through the programmed profiles and operating modes. The joystick is used to navigate within the profiles and operating modes (see above).

**[Select speed level] button**

Pressing the buttons increases/decreases the speed level. The acoustic signal changes when the maximum speed level is reached.

**[Selected speed level] LED display**

The LEDs show the currently selected speed level (1 – 5).

### 7.15.2 Joystick top



The joystick top enlarges the support surface for the hand, thereby making it easier to operate the input device.

### 7.15.3 Push-button module

The power wheelchair is equipped with a push-button module.

The push-button module lets the user select additional power seat functions directly during normal driving operation.

The order of seat functions on the push-button module corresponds to the programming stored in the control panel.

If the control device is in the "Drive" profile, the push-button module can be used in parallel.

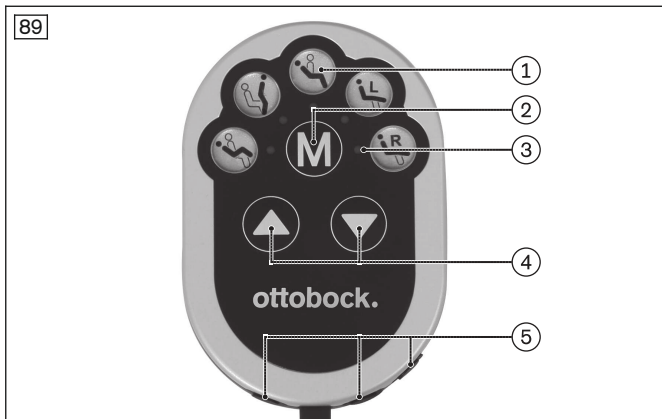





#### Push-button module overview

- 1 Available electrical functions (example)
- 2 [Mode] button
- 3 [Selected function] LED indicator
- 4 [Selected function up/down] push-buttons
- 5 Jack plugs for connecting Piko buttons

#### Seat functions that can be controlled

Depending on the power wheelchair model and programming of the push-button module, up to five power seat functions (see fig. 89, item 1) can be controlled during normal driving operation:

Display	Information
	Power seat height adjustment
	Power seat tilt
	Power back support angle adjustment

Display	Information
	Power leg support left
	Power leg support right
	Power leg supports, coupled
	Other special functions (combinations) S1 – S5

### Push-button functions

- The [Mode] button (see fig. 89, item 2) is used to toggle among the different functions (1-2-3-4-5-1-2-...).
- The blue LED (see fig. 89, item 3) indicates the selected power function.
- The respective function (function up/down) is activated using the buttons [Selected function up] and [Selected function down] (see fig. 89, item 4).

#### INFORMATION

The function of the [Selected function up/down] buttons can be programmed according to the user's wishes (button [Selected function up] = function up or function down – depending on programming).

### Accessories

Three Piko buttons that can be connected to the push-button module and positioned freely are available as options. The Piko buttons perform the same functions as the [Mode] button and the [Selected function up]/[Selected function down] buttons (see item 2/4). Symbols on the back of the push-button module indicate the corresponding functions.

#### 7.15.4 Memory function



The memory function is an additional function in "Seating" mode. Further information: see page 79; see page 80.

The following variants are available:

- Back support angle adjustment memory function – example setting: **20°**
- Seat tilt memory function – example setting: **20°**
- Back support angle adjustment/seat tilt memory function combination – example setting: **15°/15°**

The memory function causes the corresponding seat function to stop at a preset angle:

- If the memory function is activated, the corresponding seat function is deployed by moving the joystick forwards or backwards.
- The electric motor adjusts the seat function as long as the joystick is deflected and stops when the preset angle is reached.

To return the seat to its zero position, it is necessary to exit the memory function by moving the joystick to the left/right and switching to the respective "normal" seat function (e.g. seat tilt).

## 7.15.5 Centre tray control

### 7.15.5.1 Safety instructions

#### ⚠ WARNING

##### Improper use in vehicles for transporting persons with reduced mobility

Severe accidental injuries caused by use with untested product combinations

- ▶ Remove the product before using the wheelchair in a vehicle for transporting persons with reduced mobility.
- ▶ Store the product safely within the vehicle.

#### ⚠ CAUTION

##### Improper adjustment

Crushing or pinching due to adjustments which are too tight

- ▶ Do not pinch the user when sliding in the product.

#### ⚠ CAUTION

##### Collisions while driving

Crushing or pinching by the tray

- ▶ Please note that the user may be crushed by the tray in the event of a collision. Avoid collisions.

#### ⚠ CAUTION

##### Driving with objects on the tray top

Injuries due to unsecured objects

- ▶ Remove all objects from the tray top prior to travelling.

#### NOTICE

##### Improper use

Damage to the product caused by incorrect use

- ▶ Ensure that the user does not travel with the tray folded down to the side.
- ▶ Do not pull the product too far out from the receiver tube.
- ▶ Do not place any hot objects on the tray top.
- ▶ Do not overload the tray top. See the section "Technical Data" for the maximum permissible load capacity.

### 7.15.5.2 General

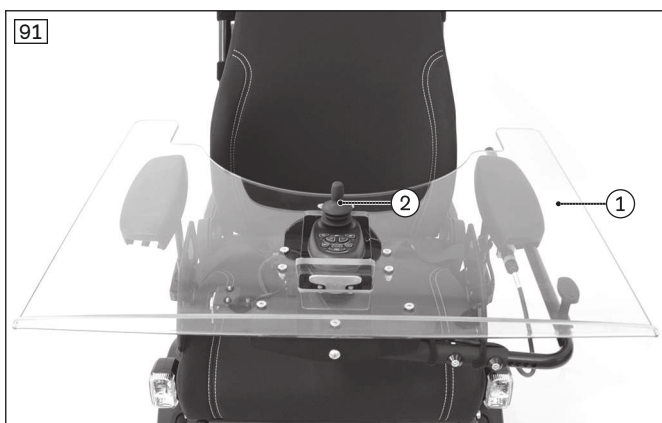

The mid-tray control device consists of a tray (see fig. 91, item 1) with a wheelchair control panel integrated in the middle (see fig. 91, item 2), as well as a charging receptacle mounted under the tray (see fig. 96).

When the control panel is folded up by hand, the tray surface is flat, and the top forms an unbroken surface. When it is folded down, the wheelchair control device automatically locks the drive function.

The mid-tray control device can be folded to the side for getting in the wheelchair and removed for transport.

### 7.15.5.3 Using the product

#### INFORMATION

- ▶ The position of the tray should have been adapted to the user by the qualified personnel.
- ▶ If necessary, the user or an attendant can readjust the position of the tray. Observe the safety notices at the beginning of the section.

**INFORMATION**

Charging the battery with the charging receptacle mounted on the tray: Charging the battery.

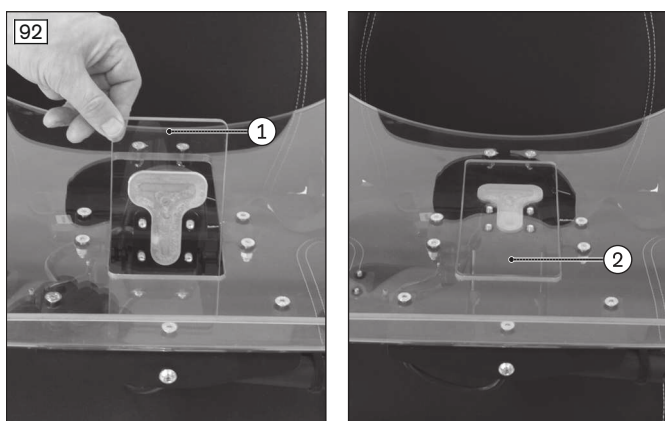
**Folding the control panel down**

- 1) Grasp the control panel mount (see fig. 92, item 1).
- 2) Fold the control panel down so the tray forms an unbroken surface (see fig. 92, item 2).

**Using the tray**

- 1) Fold the tray away to the side (see fig. 93).  
**If necessary:** pull the tray forwards (see following section).
- 2) Seat the user in the seat.
- 3) Fold the tray back.  
**If necessary:** push the tray back and close the clamping lever (see following section).  
**CAUTION! The user must not get pinched by the tray. Ensure that the user's arms can rest on the tray and that the front round cutout does not press on the user's body. Readjust the tray if necessary (see following section).**
- 4) Check that the tray is attached firmly before use.

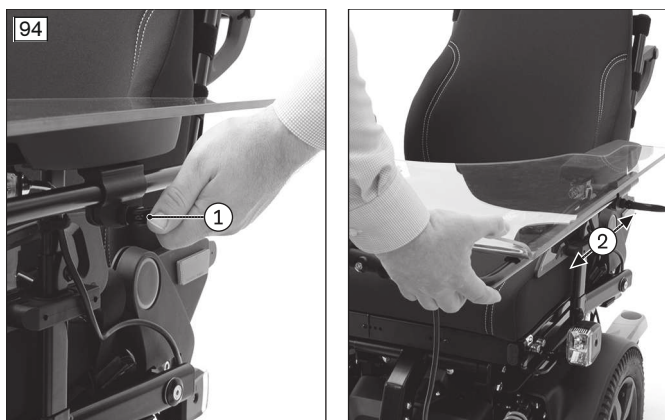
**Adjusting the tray depth**

- 1) Open the clamping lever on the swivel mechanism (see fig. 94, item 1) and pull the tray forwards slightly (see fig. 94, item 2).
- 2) Fold the tray away to the side (see fig. 93).
- 3) Seat the user in the seat.
- 4) Fold the tray back.
- 5) Push the tray back (see fig. 94, item 2) and adjust the depth. Close the clamping lever (see fig. 94, item 1).  
**CAUTION! The user must not get pinched by the tray. Ensure that the user's arms can rest on the tray and that the front round cutout does not press on the user's body.**
- 6) Firmly engage the clamping lever on the swivel mechanism.

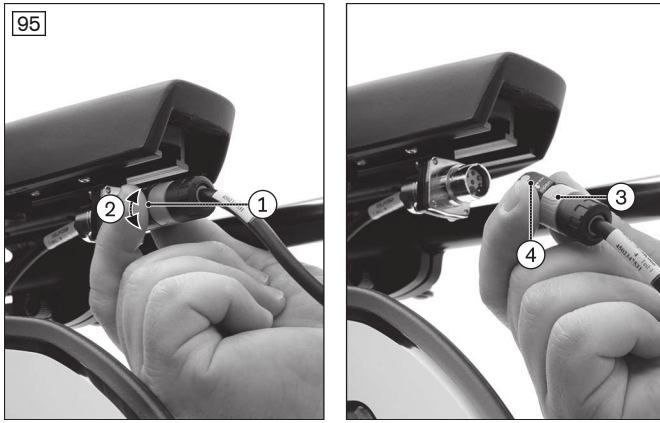

### Removing the tray for transport when necessary

- 1) Disconnect the electric power:
  - Turn the black ring on the connection plug anti-clockwise and open the bayonet connector (see fig. 95, item 1/2).
  - Pull the connection plug out (see fig. 95, item 3).
- 2) Open the clamping lever on the swivel mechanism (see fig. 94, item 1) and pull the tray forwards and out (see fig. 94, item 2).

### Reattaching the tray if necessary

- 1) Insert the tray into the clamping mechanism and push it back (see fig. 94, item 2).
 

**CAUTION! The user must not get pinched by the tray. Ensure that the user's arms can rest on the tray and that the front round cutout does not press on the user's body.**
- 2) Firmly engage the clamping lever on the swivel mechanism (see fig. 94, item 1).
- 3) Reestablish the electrical connection:
  - Insert the connection plug. The marking faces up (see fig. 95, item 4).
  - Turn the connection plug clockwise until the bayonet connector engages (see fig. 95, item 2).



### Charging process via the external charging receptacle

- 1) Turn the control device on the power wheelchair off.
- 2) Open the charging receptacle (see fig. 96, item 1).
- 3) Plug the battery charger plug into the charging receptacle.
 

**INFORMATION: Please note that the maximum permitted current for charging via the charging receptacle is 10 A.**
- 4) Connect the battery charger to the mains socket.
  - The charging process starts automatically and the battery charge level is indicated by the LCD screen on the control panel and on the battery charger.
- 5) Turn the battery charger off and pull the plug out of the mains socket when the charging process is complete.
- 6) Disconnect the battery charger plug from the charging receptacle.
- 7) Close the charging receptacle (see fig. 96, item 1).
- 8) Turn the power wheelchair control device on. The power wheelchair is ready to use.

#### 7.15.5.4 Cleaning

- 1) Clean the product with warm water and a mild detergent.
- 2) Rinse with clear water and let the product dry.

#### Important notice regarding cleaning

- Do not use any aggressive cleaners, solvents or hard brushes etc.

#### 7.15.5.5 Maintenance

In order to ensure the safety of the product, it must be maintained for the entire duration of use.

- Check the screw connections for firm fit on a regular basis.
- Replace all worn or damaged components immediately.
- Pay particular attention to cracking in the tray top.

### 7.15.6 TEN° tray module

The power wheelchair is equipped with a TEN° tray module.

The TEN° tray module is used for power swivelling of the integrated control panel on the tray of a power wheelchair.

Detailed information regarding use, cleaning and maintenance can be found in the separate 647H1446 instructions for use included with the product.

## 7.16 Special controls

### 7.16.1 Safety

#### **⚠ WARNING**

##### **Defective safety functions**

Severe injuries due to falling, tipping over, collision of the wheelchair

- ▶ Check the proper condition of the on/off switch and user switch safety devices prior to every use.
- ▶ Only use the special controls if the on/off switch and user switch are functioning.

#### **INFORMATION**

Also observe the safety notices in the section "Driving functions" (see page 53).

#### **INFORMATION**

Driving the power wheelchair in Latched mode requires increased attention by the user. Ottobock recommends special training on using the special control in Latched mode.

#### **INFORMATION**

The controls of the power wheelchair are protected according to protective system IPX4 and can thus be used in inclement weather (e.g. rain). The controls are approved for outdoor and indoor use and meet the requirements for climate and splash water.

### 7.16.2 General

#### 7.16.2.1 Switching on

Depending on the configuration, the special control can be switched on or off using the following methods:

- On/off switch on the control panel
- On/Off switch on the TEN° LCD module
- External on/off switch

A switch-off time can be set by the qualified personnel. This can automatically switch off the control unit after a specified period of time. The switch-off time can be deactivated.

#### 7.16.2.2 TEN° LCD module

The supplied joystick control was connected to the TEN° LCD module. Further information: see page 37.

The supplied button control was connected to the TEN° LCD module. Further information: see page 37.

The supplied sip and puff control was connected to the TEN° LCD module. Further information: see page 37.

### 7.16.3 Joystick controls

#### **⚠ CAUTION**

##### **Risk of uncontrolled driving behaviour**

Risk of injury due to accidental joystick movements

- ▶ The movement of the joystick controls the speed and direction. Special joysticks have significantly reduced adjustment tracks and forces.
- ▶ Before regular everyday use, practise using the controls on an open stretch of terrain.

### 7.16.3.1 Product description

The joystick control enables users who do not have sufficient hand motor skills to move the standard joystick on the control panel to control the power wheelchair.

The installed special joystick can be operated with individually adapted movement ranges and forces.

The joystick was connected to the TEN° LCD module (see page 37).

The power wheelchair was equipped with one of the following joysticks for special control functions:



- **mo-Vis Micro joystick:** very small joystick, minimal force required (approx. 10 g), operated using e.g. fingers, chin (on the left in the illustration).
- **mo-Vis Multi joystick:** smaller joystick, limited force required (approx. 50 g), operated using e.g. fingers, chin (on the right in the illustration).

The power wheelchair was equipped with one of the following joysticks for special control functions:



- **mo-Vis Allround light joystick:** standard sized joystick, moderate force required (approx. 120 g, on the left in the illustration)
- **mo-Vis Allround joystick:** standard sized joystick, normal force required (approx. 250 g). Developed for comprehensive use, this joystick is suitable for most wheelchair users. It can be used as a standard joystick, chin-operated joystick or joystick for attendants (on the left in the illustration).
- **mo-Vis Heavy Duty joystick:** large joystick, very high force required (approx. 650 g). Operated by hand or foot. Developed for users who operate their joystick with a high level of force (on the right in the illustration).

The joystick has been mounted on a chin swivel arm. This allows the power wheelchair to be controlled using the chin.

The qualified personnel programmed the movement ranges according to the specific abilities of the user.

The joystick was mounted on a holder for the tray. This makes the joystick readily accessible for the user.

The qualified personnel programmed the movement ranges according to the specific abilities of the user.



The joystick has been mounted on the arm support (see fig. 99, left). This makes the joystick readily accessible for the user.

Depending on the model, one or two further switches (user switches) have been installed next to the joystick (see fig. 99, right).

The qualified personnel programmed the movement ranges according to the specific abilities of the user.



## Piko buttons or switches

### ⚠ CAUTION

#### Incorrect positioning of the emergency stop

Risk of injury due to unreachable user switch

- The user switch with the emergency stop function (switch or Piko button) must be positioned in such a way that the user can reach it easily at any time.

The joystick control is normally combined with one or two freely positionable Piko buttons.

Alternatively, the joystick control can be combined with one or two freely positionable switches. Ottobock offers the option of integrating the switches directly into the joystick attachment (see fig. 99).

### Variant with a Piko button/switch

<b>Piko button 1 function; switch 1 function</b>	<p><b>Variant 1:</b> On/off switch for the control device; emergency stop function when actuated while driving</p> <p><b>Variant 2:</b> Profile/mode switch; briefly pressing it (approx. 1 s) retrieves the available driving profiles and operating modes of the control system in succession (dependent on programming and connected devices);</p> <p>Only with programmed sequence mode: scrolling through the menu items</p>
<b>Joystick function</b>	<p>In the driving profile (e.g. "Drive"): controlling the speed and driving direction</p> <p>In "Seating" mode: adjusting the seat option; switching to the next seat option</p> <p>In an operating mode: navigating/operating the mode; scrolling through the menu items</p>

### Variant with two Piko buttons/switches

<b>Piko button 1 function; switch 1 function</b>	On/off switch for the control device; emergency stop function when actuated while driving
<b>Piko button 2 function; switch 2 function</b>	Profile/mode switch; briefly pressing it (approx. 1 s) retrieves the available driving profiles and operating modes of the control system in succession (dependent on programming and connected devices)
<b>Joystick function</b>	<p>In the driving profile (e.g. "Drive"): controlling the speed and driving direction</p> <p>In "Seating" mode: adjusting the seat option; switching to the next seat option</p> <p>In an operating mode (e.g. "Bluetooth Device" mode): navigating/operating the mode; scrolling through the menu items</p>

### Special features of the supplied joystick control include:

- Intuitive operation
- Simple menu navigation
- Individual settings for amplification
- Modular concept for individual adaptation
- Service-friendliness thanks to simple design
- Adjustment of speed, acceleration and deceleration values to the user's individual needs.

Detailed information regarding the technical data, configuration and assembly of the individual joysticks can be found in the respective user and installation handbook provided with the joystick.

#### 7.16.3.2 Joystick commands

The following functions are typically assigned to the joystick movements:

Joystick movement	Drive mode	User menu
To the front	Forwards	Scroll up in list
To the rear	Reverse	Scroll down in list
To the right	Right turn directly after starting	Select menu item
To the left	Left turn directly after starting	

\*) **Sequence mode** can also be set for menu selection depending on programming. The menu entries can be scrolled through here by pressing the user switch.

You can switch from Drive mode to the User Menu and back by briefly pressing the user switch (approx. 1 s) **during standstill**.

Pressing the user switch **while driving** triggers an emergency stop.

### 7.16.3.3 Drive mode

The control panel or the display of the TEN° LCD module shows the defined entry point after switching on. To drive, select the drive menu and press the joystick in the desired direction of travel. The speed is increased as long as the user presses the joystick in the selected direction, or until the defined maximum speed has been reached.

The wheelchair can be braked using the following methods:

- Press the joystick in the opposite direction (fast stop).
- Stop pressing the joystick (automatic halt).

The speed decreases until the wheelchair comes to a halt. When the joystick is activated again, the wheelchair continues in the desired direction.

#### INFORMATION

The mechanical brake is automatically activated and prevents the wheelchair from rolling away when the wheelchair comes to a halt.

### 7.16.3.4 Latched drive mode

In Latched drive mode, the drive function is maintained without the user having to continuously press the joystick control. This relieves the user when driving longer distances. The joystick control needs only to be pressed until the desired speed has been reached. The wheelchair then drives with this speed until the joystick control is pressed again. Steering corrections can be made at any time while driving. The braking process is performed as described for the Drive mode (see page 98).

The following operating modes can be programmed for Latched drive mode by the qualified personnel:

- Step: Driving in step mode means that the latched speed of the wheelchair is increased or decreased using short joystick movements.
- Cruise: Joystick movement accelerates the wheelchair, and driving continues at the speed reached when the joystick is released.

Both operating modes can be programmed either only for driving forwards, or for driving forwards and in reverse.

After switching on, the LCD screen shows the following:

Display	Information
	The Latched drive mode is indicated by the symbol shown to the left.

#### INFORMATION

Latched drive mode can only be used for driving forwards and in reverse. Turning movements are not possible in Latched drive mode.

### 7.16.3.5 User switch

#### Operating with user switch

When the TEN° LCD module is used as part of the special control, the qualified personnel may also have connected a separate user switch.

**Function (standard setting):** When the user switch is pressed, the control device switches from Drive mode to the User Menu. Here the user can control the seat functions or use additional functions, such as environmental control via IR.

In standard programming, the system first toggles through the individual seat functions. The "Exit" option is then displayed, which can be used to return to Drive mode. If the user switch is pressed again while a seat function is displayed, the system moves through the operating options for the specific seat function, i.e. "Up", "Down" or "Exit". The corresponding action can also be triggered by pressing the user switch at this level.

Pressing the user switch **while driving** triggers an emergency stop.

#### INFORMATION

The standard setting can be adapted to the user's abilities by the qualified personnel through technical programming. Have the qualified personnel instruct you in the specific function of the user switch.

#### Operating without user switch

The special controls assembled with the TEN° LCD module can also be implemented without a user switch. This can be helpful if the user is unable to operate a user switch.

In this case the control device – depending on the programming – starts for example in the User Menu. When the "Exit" option is displayed, it is possible to return to Drive mode.

## 7.16.4 Push-button controls

### 7.16.4.1 Product description

With the button control, users who do not have sufficient hand motor skills to move the standard joystick on the control panel are able to control the power wheelchair. Buttons of various sizes are available for this purpose.

The push-button control has 1 button (scan function, also called scan-light control).

All functions including the driving function can be controlled using this button (exception: Bluetooth functions). The system automatically moves through the driving directions display and the menu display at a configurable speed. Pressing the button implements the currently displayed driving direction or function.

The push-button control has 3 buttons.

These buttons are used with the following functions:

- Forward/reverse
- Right
- Left

The push-button control has 4 buttons.

These buttons are used with the following functions:

- Forward
- Reverse
- Right
- Left

### 7.16.4.2 1-button control (scan function)

#### 7.16.4.2.1 Drive mode

The sampling rate in Drive mode can be programmed by the qualified personnel to adjust to the user's abilities.

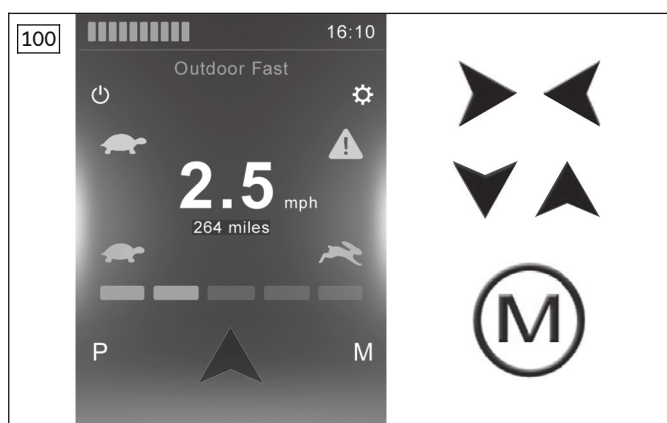

The symbol displayed at the left appears after the TEN° LCD module is switched on.

The behaviour of the wheelchair in response to operator actions depends on whether the control device is configured for "Instant" or Latched drive mode.

In **Instant drive mode** the wheelchair drives in the corresponding direction when the button is continually pressed while one of the arrow symbols shown at the left is displayed, until the button is released.

If the button is pressed when the "M symbol" appears, the TEN° LCD module switches to the User Menu.

In **Latched drive mode**, driving operation is maintained without the user having to continuously press the button. This relieves the user when driving longer distances. Latched drive mode can be used either for driving forwards only, or for driving forwards and in reverse. Briefly pressing the button when the forward arrow symbol is displayed causes the wheelchair to drive in the forward direction for a period which can be set by the qualified personnel. Correction to the left or right can be made by pressing the button when the corresponding arrow symbol is displayed (but only for a respective limited period of time; a number of corrections may need to be made).

The following operating mode can be programmed for Latched drive mode by the qualified personnel:

- **Step:** Driving in Step mode means that the latched speed is increased (when arrow is pointing in the direction of travel) or reduced (when arrow is pointing in the opposite direction) by briefly pressing the button.

Display	Information
	The Latched drive mode is indicated by the symbol shown to the left.

The wheelchair can be braked using the following methods:

- Drive command for the opposite direction (only possible in Latched drive mode, speed is reduced)
- No command (automatic halt, only in the setting without Latched mode).

The speed decreases until the wheelchair comes to a halt. The wheelchair resumes driving in the desired direction when the corresponding drive command is entered again.

#### INFORMATION

The mechanical brake is automatically activated and prevents the wheelchair from rolling away when the wheelchair comes to a halt.

#### 7.16.4.2.2 User menu

Switching from Drive mode to the User Menu by pressing the user switch is only possible if the M symbol is shown on the LCD screen (see above).

**Function (standard setting):** When the user switch is pressed, the control device switches from Drive mode to the User Menu. Here the user can control the seat functions or use additional functions, such as environmental control via IR.

In standard programming, the system first toggles through the individual seat functions. The "Exit" option is then displayed, which can be used to return to Drive mode. If the user switch is pressed again while a seat function is displayed, the system moves through the operating options for the specific seat function, i.e. "Up", "Down" or "Exit". The corresponding action can also be triggered by pressing the user switch at this level.

Pressing the user switch **while driving** triggers an emergency stop.

#### INFORMATION

The time each function is displayed by the TEN° LCD module can be programmed by the qualified personnel. Have the qualified personnel instruct you in the specific function of the user switch.

#### 7.16.4.3 3-button control

The following functions are typically assigned to the buttons:

3 buttons	Drive mode	User menu
Front/back**)	Forwards	Scroll up in list
	Reverse	Scroll down in list
Right	Turn right	Select menu item
Left	Turn left	

\*) **Sequence mode** can also be set for menu selection depending on programming. The menu entries can be scrolled through here by pressing the user switch.

\*\*\*) Depending on programming, switching between forwards and backwards can be carried out by simply pressing the user switch or through an automatic change in direction by pressing the front/back button.

#### Switching between forwards and reverse using the user switch

Pressing the user switch once switches the direction for the front/back button. You can switch from Drive mode to the User Menu and back by double-clicking the user switch **during standstill**.

Pressing the user switch **while driving** triggers an emergency stop.

#### Switching between driving forwards and in reverse using automatic change in direction by activating the front/back button

After pressing and releasing the "front/back" button, the command is automatically interpreted in the opposite direction the next time the button is activated. This sequence must be completed within a specified period of time (typically 2 seconds; can be changed using programming). If the sequence is not finished within this period, activation of the button is interpreted as a driving command in the previously set direction (no change in direction).

You can switch from Drive mode to the User Menu and back by briefly pressing the user switch (approx. 1 s) **during standstill**.

Pressing the user switch **while driving** triggers an emergency stop.

#### 7.16.4.3.1 User switch

##### Operating with user switch

When the TEN° LCD module is used as part of the special control, the qualified personnel may also have connected a separate user switch.

**Function (standard setting):** When the user switch is pressed, the control device switches from Drive mode to the User Menu. Here the user can control the seat functions or use additional functions, such as environmental control via IR.

In standard programming, the system first toggles through the individual seat functions. The "Exit" option is then displayed, which can be used to return to Drive mode. If the user switch is pressed again while a seat function is displayed, the system moves through the operating options for the specific seat function, i.e. "Up", "Down" or "Exit". The corresponding action can also be triggered by pressing the user switch at this level.

Pressing the user switch **while driving** triggers an emergency stop.

#### INFORMATION

The standard setting can be adapted to the user's abilities by the qualified personnel through technical programming. Have the qualified personnel instruct you in the specific function of the user switch.

### Operating without user switch

The special controls assembled with the TEN° LCD module can also be implemented without a user switch. This can be helpful if the user is unable to operate a user switch.

In this case the control device – depending on the programming – starts for example in the User Menu. When the "Exit" option is displayed, it is possible to return to Drive mode.

#### 7.16.4.4 4-button control

The following functions are typically assigned to the buttons:

4 buttons	Drive mode	User menu
Forward	Forwards	Scroll up in list
Back	Reverse	Scroll down in list
Right	Turn right	Select menu item
Left	Turn left	

\*) **Sequence mode** can also be set for menu selection depending on programming. The menu entries can be scrolled through here by pressing the user switch.

You can switch from Drive mode to the User Menu and back by briefly pressing the user switch (approx. 1 s) **during standstill**.

Pressing the user switch **while driving** triggers an emergency stop.

#### 7.16.4.4.1 User switch

### Operating with user switch

When the TEN° LCD module is used as part of the special control, the qualified personnel may also have connected a separate user switch.

**Function (standard setting):** When the user switch is pressed, the control device switches from Drive mode to the User Menu. Here the user can control the seat functions or use additional functions, such as environmental control via IR.

In standard programming, the system first toggles through the individual seat functions. The "Exit" option is then displayed, which can be used to return to Drive mode. If the user switch is pressed again while a seat function is displayed, the system moves through the operating options for the specific seat function, i.e. "Up", "Down" or "Exit". The corresponding action can also be triggered by pressing the user switch at this level.

Pressing the user switch **while driving** triggers an emergency stop.

#### INFORMATION

The standard setting can be adapted to the user's abilities by the qualified personnel through technical programming. Have the qualified personnel instruct you in the specific function of the user switch.

### Operating without user switch

The special controls assembled with the TEN° LCD module can also be implemented without a user switch. This can be helpful if the user is unable to operate a user switch.

In this case the control device – depending on the programming – starts for example in the User Menu. When the "Exit" option is displayed, it is possible to return to Drive mode.

#### 7.16.5 Sip and puff control

##### 7.16.5.1 Product description

This option allows the user to control the power wheelchair by sipping or puffing using a special mouthpiece.

The sip and puff control was connected to the TEN° LCD module (see page 37).

Special features of the sip and puff control are:

- Individually adjustable
- Safe method of operation and reliable function
- Easy servicing due to simple design
- Easy mouthpiece change ensures hygienic usage
- Intuitive operation
- Simple menu navigation
- Adjustment of speed, acceleration and deceleration values to the user's individual needs.

#### 7.16.5.2 Sip and puff commands

The following command types are available for operating the sip and puff control:

- Strong puffing or sipping
- Light puffing or sipping

The following sip and puff commands are used to control the wheelchair:

Puffing	Sipping	Drive mode	User menu
Strong		Forwards	Scroll up in list
	Strong	Reverse	Scroll down in list
Light		Turn right	Select menu item
	Light	Turn left	

\*) **Sequence mode** can also be set for menu selection depending on programming. The menu entries can be scrolled through here by pressing the user switch.

You can switch from Drive mode to the User Menu and back by briefly pressing the user switch (approx. 1 s) **during standstill**.

Pressing the user switch **while driving** triggers an emergency stop.

#### Operating without user switch

The sip and puff control can also be realised without a user switch. This can be helpful in particular if the user is unable to operate a user switch. The following options are available here, depending on programming by the qualified personnel:

- If no sip and puff command is given for an adjustable period of time, the control device automatically switches from Drive mode to the User Menu, which can then be operated using sip and puff commands as shown in the above table.
- Issuing two sip or puff commands in quick succession (the time can be programmed) simulates briefly pressing the user switch and switches to the User Menu.

#### INFORMATION

##### **If there is no user switch, an emergency stop can only be carried out via the on/off switch**

The decision to forego the user switch is made by the qualified personnel after carefully considering the situation in which the special control is used.

#### 7.16.5.3 Drive mode

The TEN° LCD module shows the defined entry point after switching on. Use the menu navigation to select Speed level; to drive, operate the sip and puff control by sipping or puffing at the mouthpiece according to the sip and puff commands. Closing the mouthpiece with your tongue causes the system to maintain the pressure or underpressure previously created by sipping or puffing. The wheelchair then continues its motion without the need for continuous sipping or puffing.

The wheelchair can be braked using the following methods:

- Sip and puff command for the opposite direction (fast stop)
- No command – or move tongue from mouthpiece (automatic halt), as long as the control device is not in Latched drive mode.

The speed decreases until the wheelchair comes to a halt. It continues to drive in the desired direction when the sip and puff command is reissued.

#### INFORMATION

The mechanical brake is automatically activated and prevents the wheelchair from rolling away when the wheelchair comes to a halt.

### 7.16.5.4 Cleaning and Care

#### ⚠ CAUTION

##### Incorrect cleaning

Injuries due to product damage, infections/skin irritations due to user error

- ▶ Water must not come into direct contact with the electronics under any circumstances during cleaning.
- ▶ Use a cloth or sponge for cleaning.
- ▶ To avoid corrosion, do not use any aggressive cleaning agents or solvents.
- ▶ Check the driving behaviour of the product after cleaning it.

Clean the mouthpiece of the sip and puff control daily and replace it at regular intervals if used frequently.

The connecting tubes of the sip and puff control between the mouthpiece and signal converter module can be disconnected and rinsed with water.

### 7.16.6 Swivel arm

The installed swivel arm offers the option of power-swivelling the special control elements to a passive position for getting in and out as well as to an active position for controlling the wheelchair.

The swivel arm is operated by installing what is known as a satellite switch.

#### 7.16.6.1 Functions of the satellite switch

The satellite switch is mounted on the right or left side.

The satellite switch has the following functions:

Activating the satellite switch	Satellite switch	Function
	Raise	Swing in
	Lower	Swing out
	Move towards operator	On/off, EMERGENCY STOP
	Move away from operator	User switch

#### 7.16.6.2 Operating the swivel unit

The functions are stored in the standard programming as follows (special programming per customer request possible).

- When the satellite switch is moved upwards, the swivel arm with the special control elements is swung into the active position to control the wheelchair.
- When the satellite switch is moved downwards, the swivel arm with the special control elements is swung into the passive position for getting in and out.
- A toggle switch is located on the swivel unit for operation of the swivel arm by an attendant. The symbols on the toggle switch for swivelling in and out are the same as on the satellite switch.

### 7.16.7 Wireless environmental control

#### ⚠ CAUTION

##### Incorrect installation and programming

Injuries due to falling, tipping over or collision of the wheelchair due to unexpected behaviour.

- ▶ Mounting, connecting and programming special controls, including the environmental control, is to be performed only by qualified personnel.

**NOTICE**

**Use of devices with electromagnetic emissions**  
 Restriction of function due to electromagnetic fields

- ▶ The performance of the product can be affected by electromagnetic fields (highly radiating devices such as amateur radio or superimposed frequencies). If necessary, switch such devices off while using this product.

**INFORMATION**

The control device offers additional environmental control functions by default:

- ▶ The integrated Bluetooth function supports the wireless operation of PCs, smartphones/tablets (Android 4.0 or higher) and iOS devices (iPhone, iPad) directly from the control panel. Further information: see page 45.
- ▶ The integrated IR function makes it possible to control a wide range of different infrared devices. Further information: see page 50.

**INFORMATION**

Please note: The name of the mode for controlling household devices has been designated "IOM3" at delivery. The name can be individually modified by the qualified personnel prior to handover to the user.

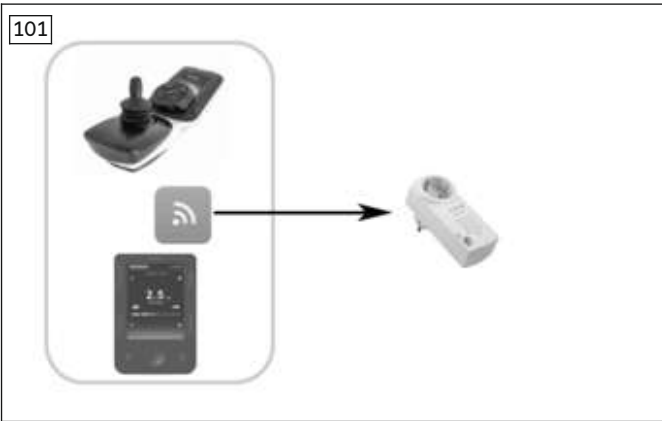

An additionally available wireless module makes it possible to control up to 6 building services receivers (e.g. outlets, light switches, roller shutters, etc.) wirelessly via the control panel.

The wireless module is a transmitter (frequency 868.30 MHz), which uses the Easywave protocol especially developed for building services. This protocol is used in numerous building services products available in the market.

The maximum tested driving distance range is **20 m**.

The devices being controlled must be synchronised with the control device prior to use. Synchronisation is performed by the qualified personnel.

**Entering/exiting "IOM3" mode**

Enter/exit the environmental control mode for devices with infrared remote control as follows:

- **TEN° control panel:** Repeatedly pressing the [Profile/Mode] button calls up the profiles and operating modes in succession (Buttons and display functions; dependent on programming).
- **TEN° LCD module:** Repeatedly pressing the [Mode] button calls up the operating modes in succession (Buttons and display functions; dependent on programming).
- When "IOM3" mode is reached, the programmed building services devices can be wirelessly controlled (see below).
- **TEN° control panel:** Pressing the [Profile/Mode] button again allows you to switch to further operating modes and back to the driving profiles (dependent on programming).
- **TEN° LCD module:** Pressing the [Mode] button again allows you to switch to further operating modes (dependent on programming).

**LCD screen in "IOM3" mode**

Display	Information
	"IOM3" mode active The devices being controlled must be synchronised with the control device prior to use. Synchronisation is performed by the qualified personnel.



## Operating devices

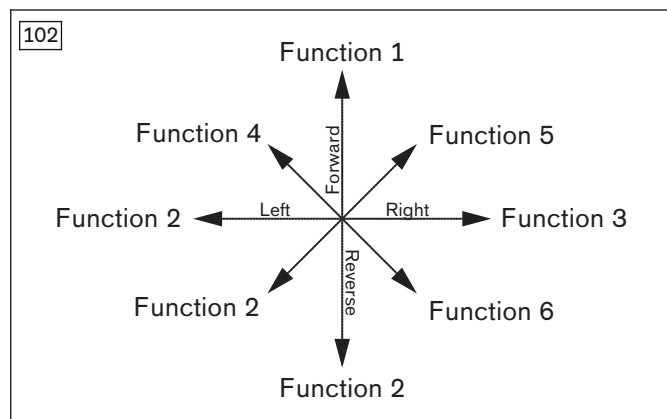

The desired function can be controlled in "IOM3" mode by moving in the corresponding direction using the respective installed input device.

**Example:** Function 1 is started by moving the joystick forwards.

## 7.17 Additional options

### 7.17.1 Control panel holder

#### Swing-away control panel holder

The control panel holder makes it possible to drive the power wheelchair under a table or closer to an object. The control panel holder can be rotated up to the armrest.



#### Swinging away the control panel holder

- 1) Apply slight pressure to push the control panel holder to the side.  
→ The pivot element is unlocked.
- 2) Swing the control panel holder away to the side.  
**INFORMATION: The pivot element locks in place again when the holder is rotated back to the original position.**



#### Swinging away the control panel holder

- 1) Apply slight pressure to push the control panel holder to the side.  
→ The pivot element is unlocked.
- 2) Swing the control panel holder away to the side.  
**INFORMATION: The pivot element locks in place again when the holder is rotated back to the original position.**



### Swinging away the control panel holder

- 1) Apply slight pressure to push the control panel holder to the side.  
→ The pivot element is unlocked.
- 2) Swing the control panel holder away to the side.  
**INFORMATION: The pivot element locks in place again when the holder is rotated back to the original position.**

## 7.17.2 Lighting

Information on replacing broken lamps: see page 125.

### 7.17.2.1 Lighting for road traffic

The installed lighting permits driving in road traffic during hours of darkness, and is only approved for use on motorised wheelchairs.

The light, the right and left direction indicators and the warning flashers are operated via the control panel.

#### Front lighting

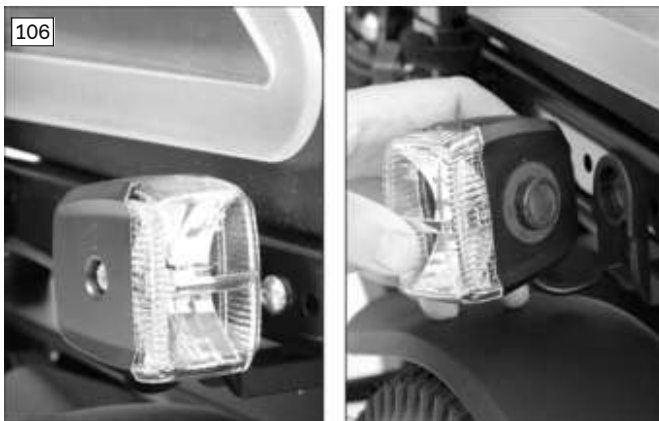

The front lighting consists of 2 front lights with integrated direction indicators (see fig. 106, left).

To prevent damage while manoeuvring in confined spaces, the front lighting is attached to the wheelchair magnetically.

If the front lighting has been disconnected from the holder, it can simply be reinserted in the prior position (see fig. 106, right).

When connecting the lights, make sure there are no foreign objects on the magnets.

The lighting angle is secured by latches.

#### Rear lighting



The rear lighting consists of 2 LED rear lights with integrated direction indicators.

### 7.17.2.2 Lighting (not intended for road traffic)

The installed lighting makes driving on footpaths easier during hours of darkness. Power wheelchairs with this equipment are not permitted for use in road traffic.

The lighting is mounted on the front right side in the driving direction. The lighting angle is secured by latches.



The integrated daylight sensor (see fig. 108, arrow) causes the light to turn on and off automatically depending on the outdoor light level when the control unit is on.

**INFORMATION: Clean the daylight sensor regularly so the outdoor light level is detected accurately.**

### 7.17.3 Belts/belt systems

#### INFORMATION

Information on the lap belt: see page 82.

The following instructions for adjustment and use apply to four-way chest straps, upper body straps and vests as well as chest/shoulder straps.

#### 7.17.3.1 Adaptation

#### CAUTION

##### Improper adjustments

Injuries, malpositions, illness of the user due to adjustment changes

- ▶ The belt system is an important part of an individual seating unit/seating solution. Do not modify the installation position and basic settings established by the qualified personnel.
- ▶ In case of problems with these adjustments (such as an unsatisfactory sitting position), promptly contact the qualified personnel who fitted the product.
- ▶ **Immediately** consult the qualified personnel if you notice signs of discomfort or fear when using a belt system.
- ▶ Have the basic settings of the belt system checked regularly. Adjustments may be required due to the growth of the user or because of changes in the course of the disease.

Small length adjustments of the belt by the user or an attendant (e.g. for clothing of different thickness) are possible.

##### Positioning the user in the seat

- Place the user in an upright, 90° seated position (if physiologically possible).
- Ensure that the back is up against the backrest padding (if physiologically possible).
- **Applies only to upper body straps/vests, chest/shoulder straps:**
  - Ensure that the height of the backrest on the product is adjusted correctly. The top of the backrest must be at the height of the shoulders.
  - The belt system is intended to support the area of the upper body (breastbone) from the front. The upper and lower straps have to be adjusted as needed.
  - Ensure that the positioning system is not too close to the throat. Otherwise the upper straps have to be readjusted.

##### Possible positioning errors

- The user's hips are not secured with a separate lap belt (see page 82).
- If the positioning system is too loose, the user can shift forward/slide down.
- The positioning system collides with devices, accessories or supply hoses during installation and adjustment, restricting their functionality.
- **Applies only to upper body straps/vests, chest/shoulder straps:**
  - The positioning system is too close to the throat, endangering the user.
  - The positioning system makes contact with the user in the area of the soft part of the stomach (too low).

### Adjusting the belt length

Notes on correct adjustment are found in the instructions for use included with the belt system.

#### 7.17.3.2 Use

##### **⚠ WARNING**

##### **Incorrect application**

Throttling, suffocation or strangulation due to sliding forward/down in the product

- ▶ The belt system must be used at all times while riding in the product. Always use the belt system in combination with a correctly applied and adapted positioning lap belt to stabilise the pelvis.
- ▶ The belt system has to fit closely but not too tightly so the user is not injured. Sliding two fingers comfortably between the positioning system and upper body should be possible.
- ▶ Ensure that the buckle lies in the middle of the body.
- ▶ Ensure that the belt system is not too close to the throat. Otherwise the upper straps have to be readjusted.
- ▶ Remove any objects or clothing which get caught.

##### **⚠ CAUTION**

##### **Incorrect application**

Risk of pressure points, constriction due to user error

- ▶ **Applies only to upper body straps/vests, chest/shoulder straps:** Follow the positioning instructions. Ensure that the belt system lies against the chest evenly on both sides and is not too tight.
- ▶ **Applies only to upper body straps/vests, chest/shoulder straps:** Ensure that the belt system supports the area of the upper body from the front. The belt system has to be applied/positioned so that the neck and area of the throat remain free at all times.

##### **⚠ CAUTION**

##### **Improper use**

Falls, user falling out due to improper use

- ▶ Only open the belt system and the applied lap belt when the user is ready to get out of the product.
- ▶ Do not leave the user unsupervised if the cognitive abilities of the user could lead to unintentional opening of the belt system.
- ▶ Information about subsequent acquisition and mounting is provided by the qualified personnel that handed the product over to you.

##### **⚠ CAUTION**

##### **Medical risks**

Injuries, pressure sores due to application errors

- ▶ Regular measures for pressure redistribution and skin examinations are required. Should skin irritation and/or skin reddening occur, consult the qualified personnel who adapted and adjusted the product. Do not continue using the product without consultation.

The belt system can be used for additional positioning of the user in the power wheelchair.

### Applying the belt system

Notes on correct application are found in the instructions for use included with the belt system.

### Cleaning a belt system with metal closure

##### **INFORMATION**

Observe the washing recommendations on the product and the information in the corresponding instructions for use provided for the product.

- Straps with metal closures **may not be washed in the washing machine** as the penetration of water could cause corrosion and subsequent malfunctions.
- Clean the belt straps by gently dabbing them with warm soapy water (with some disinfectant) or carefully wipe with a dry, clean, absorbent cloth.

### Cleaning a belt system with plastic closure

- Depending on the model, belts/straps with plastic buckles can be washed in the washing machine between **40 °C** and **60 °C**.
- **Recommendation:** Use a laundry bag or net and mild detergent.
- Alternatively, the belt straps can be cleaned by gently dabbing them with warm soapy water (with some disinfectant) or carefully wiped with a dry, clean, absorbent cloth.

### Additional cleaning instructions

- Allow the belts to air dry. Ensure that the belts and pads are completely dry before installation.
- Do not expose the belts to direct heat (e.g. sunshine, stove or radiator).
- Do not iron or bleach the belts.

### 7.17.4 Caster wheel swivel lock

The caster wheel swivel lock is used to lock the caster wheels in the forward direction so turning is no longer possible. Having the power wheelchair drive in a perfectly straight line increases safety when driving on ramps or using lifts.

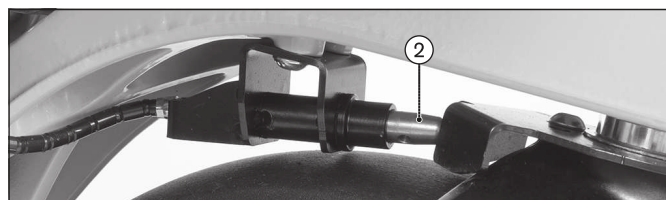

#### Engaging the caster wheel swivel lock

- 1) Push the release lever down (see fig. 109, item 1).
- 2) The caster wheel swivel lock bolt engages in the front fork (see fig. 109, item 2). The power wheelchair drives straight in both forward and reverse.

**NOTICE!** Please note that the caster wheel swivel lock functions by manual means and has no impact on the joystick functions. Please avoid excessive steering movements on the joystick. This could result in a high mechanical load on the caster wheel swivel lock and thereby to a defect.

**INFORMATION:** Clean the caster wheel swivel lock bolt if it gets dirty.

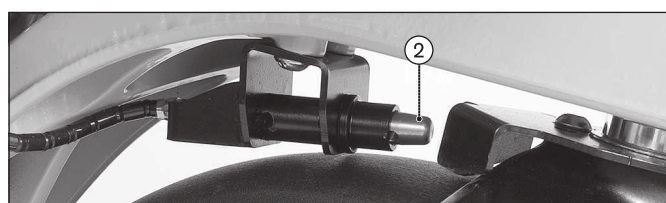

#### Releasing the caster wheel swivel lock

- 1) Push the release lever up (see fig. 110, item 1).
- 2) The caster wheel swivel lock bolt (see fig. 110, item 2) releases the front fork again. The caster wheels are unlocked and can swivel freely again.

### 7.17.5 Spring-mounted caster wheel swing arm



The spring elements on the caster wheel swing arms increase driving comfort, especially when driving on rough terrain.

They also improve traction.

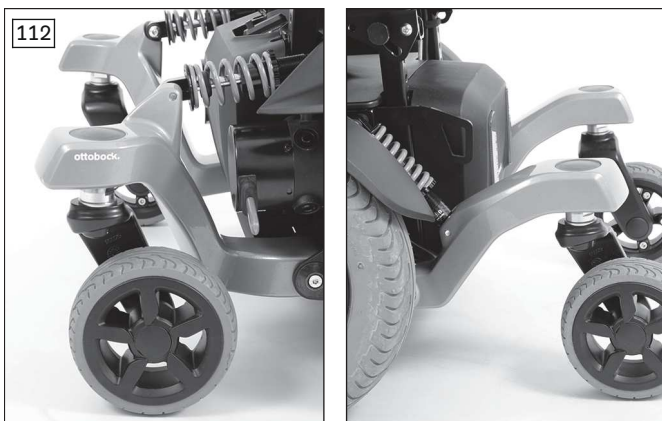

The spring elements on the front and rear caster wheel swing arms improve driving comfort, especially when driving on rough terrain.

They also improve traction.

### 7.17.6 Mechanical track stabiliser



The mechanical track stabiliser (see fig. 113, item 1) under the caster wheel swing arm stabilises the caster wheels when moving forward at high speeds.

As a result, the track is better maintained when driving straight forwards (e.g. in road traffic).

### 7.17.7 Mechanical track stabiliser with ASM



The mechanical track stabiliser with ASM (Advanced Stability Module) stabilises the power wheelchair at high speeds.

A built-in mechanism (see fig. 113, item 1) stabilises the caster wheels underneath the caster wheel swing arm. In addition, the "Advanced Stability Module" (ASM) (see fig. 114) reduces excessive turning of the wheels in case of extreme directional deviations with the help of acceleration sensor technology.

Thanks to the combination of both technologies, the directional stability is improved and the risk of skidding is considerably reduced while driving fast, either straight ahead or in curves (e.g. in road traffic).

### 7.17.8 Electronic track stabiliser

#### INFORMATION

Because the electronic track stabiliser feature is disrupted by the movement of public means of transportation (bus; train; ship), the user must activate the "No Assist" driving profile prior to driving in public means of transportation for safety reasons (see page 38). The electronic track stabiliser is switched off in this driving profile.

A gyro module is integrated into the control system.

The gyro module combines signals from a joystick with positional and directional information provided by a gyroscope. The system can thereby detect whether the power wheelchair is deviating from the specified straight line and automatically correct the driving path.

This not only eliminates inconvenient driving corrections, but also enables precise manoeuvring on various surfaces and slopes.

### 7.17.9 Tray

#### 7.17.9.1 Safety instructions

#### ⚠ WARNING

##### Improper use in vehicles for transporting persons with reduced mobility

Severe accidental injuries caused by use with untested product combinations

- ▶ Remove the product before using the wheelchair in a vehicle for transporting persons with reduced mobility.
- ▶ Store the product safely within the vehicle.

#### ⚠ WARNING

##### Inflammable product

Burns due to user error

- ▶ The product is flame retardant. Nevertheless, the possibility that it may catch fire cannot be entirely excluded in case of exposure to an ignition source. Therefore, the utmost caution must be exercised in the vicinity of an open flame.
- ▶ Keep away from all ignition sources, especially lit cigarettes.

#### ⚠ CAUTION

##### Improper adjustment

Crushing or pinching due to adjustments which are too tight

- ▶ Do not pinch the user when sliding in the product.

#### ⚠ CAUTION

##### Collisions while driving

Crushing or pinching by the tray

- ▶ Please note that the user may be crushed by the tray in the event of a collision. Avoid collisions.

**CAUTION****Driving with objects on the tray top**

Injuries due to unsecured objects

- ▶ Remove all objects from the tray top prior to travelling.

**NOTICE****Improper use**

Damage to the product caused by incorrect use

- ▶ Do not place any hot objects on the tray top.
- ▶ Do not overload the tray top. See the section "Technical Data" for the maximum permissible load capacity.

**7.17.9.2 Using the product****INFORMATION**

- ▶ The position of the tray should have been adapted to the user by the qualified personnel.
- ▶ If necessary, the user or an attendant can readjust the position of the tray.

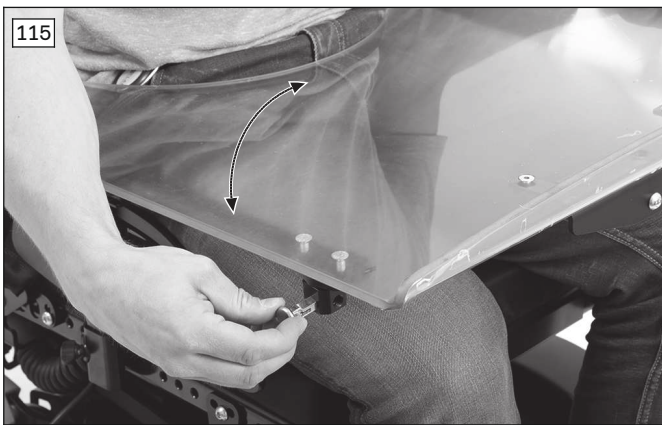
**Using the tray**

- 1) Pull the pin and swing the tray away to the side (see fig. 115).
- 2) Seat the user in the seat.
- 3) Fold the tray down and lock it with the pin.  
**CAUTION! The user must not get pinched by the tray. Ensure that the user's arms can rest on the tray and that the front, round cutout does not press on the user's body. Readjust the tray if necessary (see following section).**
- 4) Check that the tray is attached firmly before use.

**Readjusting the tray depth**

- 1) Open the clamping lever on the swivel mechanism and pull the tray forward slightly (see fig. 116).
- 2) Pull the pin and swing the tray away to the side (see fig. 115).
- 3) Seat the user in the seat.
- 4) Fold the tray down and lock it with the pin.
- 5) Adjust the depth.  
**CAUTION! The user must not get pinched by the tray. Ensure that the user's arms can rest on the tray and that the front, round cutout does not press on the user's body.**
- 6) Firmly engage the clamping lever on the swivel mechanism.





### Removing the tray when necessary

- 1) Pull the pin and swing the tray away to the side (see fig. 115).
- 2) Open the clamping lever on the swivel mechanism and pull the tray out to the front (see fig. 116). The clamping mechanism remains under the arm support (see fig. 117, left).
- 3) Remove the clamping profile on the side of the control panel (see fig. 117, right). To do so, loosen and remove the 2 set screws and 1 slide block on the bottom of the arm support.
- 4) Pull out the clamping profile towards the front.

### 7.17.9.3 Cleaning

- 1) Clean the product with warm water and a mild detergent.
- 2) Rinse with clear water and let the product dry.

### Important notice regarding cleaning

- Do not use any aggressive cleaners, solvents or hard brushes etc.

### 7.17.9.4 Maintenance

In order to ensure the safety of the product, it must be maintained for the entire duration of use.

- Check the screw connections for firm fit on a regular basis.
- Replace all worn or damaged components immediately.
- Pay particular attention to cracking in the tray top.

### 7.17.10 Luggage carrier

#### NOTICE

#### Overloading the luggage carrier

Damage to product due to breakage

- ▶ The maximum load for the luggage carrier is **15 kg (33 lbs)**.
- ▶ Please note that the maximum load of the overall product must not be exceeded, also after loading the luggage carrier (see page 133).

#### NOTICE

#### Improper use of the seat tilt/back angle adjustment

Damage to the luggage carrier due to collision with the seat back

- ▶ Note that the seat back may collide with the luggage carrier when the seat tilt or back angle adjustment is fully tilted. In this case, remove the luggage carrier before using the seat adjustment.
- ▶ Note that the seat back may collide with items on the luggage carrier even with only a slight tilt. Take the items off the luggage carrier in this case. If this is not possible, then the seat or seat back must not be adjusted too far back.

#### INFORMATION

- ▶ Note that the centre of gravity of the power wheelchair shifts to the rear when the luggage carrier is fully loaded.
- ▶ This may lead to unfamiliar steering and driving behaviour.

The luggage carrier can be used to store additional luggage. The luggage carrier can be removed if required.

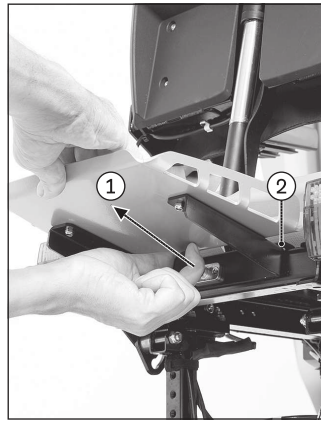
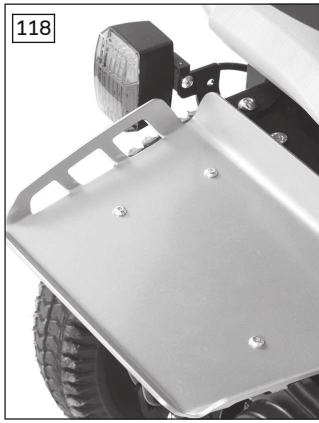

### Removing the luggage carrier

- 1) Pull out the release bolt under the tray (see fig. 118, item 1).
- 2) Slightly lift the luggage carrier and take it off the support bar (see fig. 118, item 2).

### Attaching the luggage carrier

- 1) Slightly lift the luggage carrier and set it onto the support bar (see fig. 118, item 2).
- 2) Push the luggage carrier down until the release bolt (see fig. 118, item 1) engages.

## 7.17.11 Curb climbing assist

The curb climbing assist makes it possible to overcome curbs and steps with a maximum height of **100 mm (4")**.

**INFORMATION: Deviating values for other wheel combinations, see the section "Technical data".**



### Using the curb climbing assist

- > The curb climbing assist must protrude to the front when driving outdoors.
  - 1) Drive against an obstacle (e.g. a high curb).
  - 2) The curb climbing assist lifts the power wheelchair over the obstacle.
  - 3) After crossing the obstacle, the curb climbing assist returns to the active, forward-facing position.

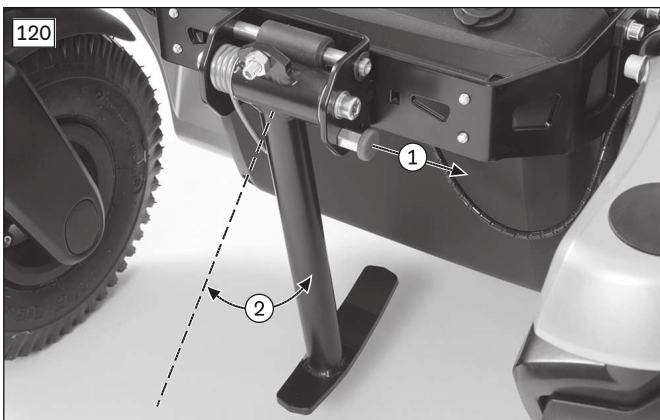

### Temporarily deactivating the curb climbing assist

- > The curb climbing assist can be deactivated when driving indoors.
  - 1) Pull the release button (see fig. 120, item 1).
  - 2) Swing the curb climbing assist back until the locking mechanism engages (see fig. 120, item 2).
  - 3) The curb climbing assist is deactivated.

## 7.17.12 External power supply

### NOTICE

#### Overloading the connections

Power supply defect

- ▶ Avoid using all connections at full capacity at the same time.

The external power supply is used to charge or operate external devices such as mobile phones, laptops or oxygen units.

The type of power supply is embossed in the cover cap. The sides can be chosen as desired.



#### Possible connections:

**USB:** The connection can be used to charge or operate devices with a standard USB battery charger (see fig. 121, item 1). Outputs: 5 V; to 1 A; 5 V to 2.1 A.

**12 V:** The connection can be used to charge or operate devices with a 12 V motor vehicle power adapter ("Cigarette lighter plug"; see fig. 121, item 2). Output: up to 5 A. Power output: maximum 60 W.

**24 V:** The connection can be used to charge or operate devices with a 24 V motor vehicle power adapter (not illustrated). Output: up to 3 A. Power output: maximum 72 W.

#### 7.17.13 Hand heater

The hand heater with a cover for one or two hands is an option for installation on Ottobock power wheelchairs. The product produces a stream of warm air that increases the temperature in the area of the control panel under cold ambient conditions.

Detailed information regarding use, cleaning and maintenance can be found in the included instructions for use.

#### 7.17.14 Backpack hook

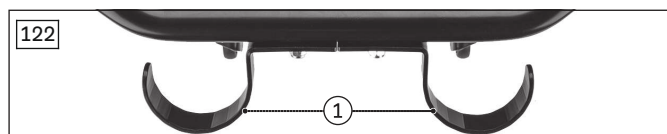

The hook is intended for hanging a backpack on the back support.

The maximum permissible weight of the backpack is **10 kg**.

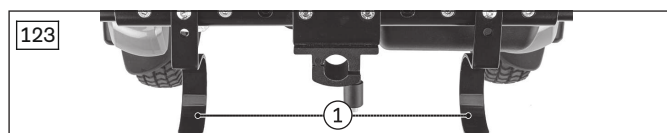

The hook is intended for hanging a backpack on the back support.

The maximum permissible weight of the backpack is **10 kg**.

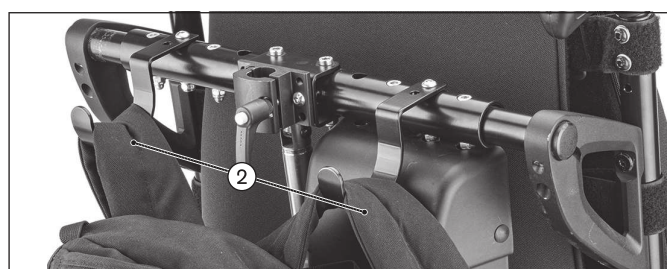

#### 7.17.15 Overview of other options

##### INFORMATION

You can find these and other optional add-on components on the order form and in the accessories catalogue.

The power wheelchair is equipped with additional options:

- Splash guard for drive wheels
- Splash guard for caster wheels
- Crutch holder

- Folding rearview mirror
- Rear marker plate
- External horn
- Pocket for mobile phone
- Beverage holder
- Tool kit
- Airman pump

## 7.18 Disassembly and transport

### 7.18.1 Safety instructions

#### **⚠ WARNING**

##### **Improper transportation in aircraft**

Burns, explosion or damage to the battery due to failure to observe the rules for transportation

- ▶ Follow the rules of the IATA (International Air Transport Association) and the respective airline when transporting the power wheelchair in an aircraft. Before checking in the power wheelchair, the automatic circuit breaker has to be deactivated and the battery connectors must be insulated so they cannot short-circuit.
- ▶ Note that those batteries in particular which may leak or will not be transported upright must be removed and packaged so they cannot leak or short circuit.
- ▶ For more information please visit the [www.iata.org](http://www.iata.org) website. The manufacturer recommends contacting the airline directly before every flight to obtain information regarding special transport regulations.
- ▶ Use the SSR (special service request) codes to describe the type of limited mobility if necessary. You can for example research these on the Internet.

#### **⚠ CAUTION**

##### **Securing the power wheelchair insufficiently during transport**

Crushing, pinching of body parts due to failure to observe transportation instructions

- ▶ During transportation in vehicles or aircraft, on lifting platforms or in lifts, turn the control unit of the power wheelchair off and lock the brake.
- ▶ The power wheelchair must be secured in accordance with the regulations for the transport device.
- ▶ During transport in a vehicle, the power wheelchair must be secured sufficiently with cargo straps. Only attach the cargo straps to the corresponding transportation eyelets and specified tie-down points.

#### **NOTICE**

##### **Lifting the power wheelchair incorrectly**

Damage to the power wheelchair due to failure to observe transportation instructions

- ▶ Hoisting devices used for transportation must have a sufficient capacity. For more information about weight, see the section "Technical data" (see page 133).
- ▶ Do **not** attach the hoisting devices on moveable or adjustable components.
- ▶ Ensure that the seat is lowered all the way and the backrest is in a vertical position prior to loading and for transporting the power wheelchair.

### 7.18.2 Reducing the transportation size

#### **INFORMATION**

Please note that the foot supports of the centrally mounted leg support must always be folded up all the way to the back when being transported to prevent them from folding down on their own.

The transportation size can be reduced in a few steps to make transporting the product easier.

124

**Preparing for transport**

- 1) Fold the backrest forward and onto the seat surface (see page 26).
- 2) Remove the side panels (see page 20). Place the side panel on the seat.
- 3) Remove the legrests (see page 23).

125

**Preparing for transport**

- 1) Fold the backrest forward and onto the seat surface (see page 26).
- 2) Remove the side panels (see page 20). Place the side panel with control panel on the seat.
- 3) Remove the legrests (see page 23).

126

**Preparing for transport**

- 1) Fold the back support forward and onto the seat surface (see page 26).
- 2) Remove the side panels (see page 20). Place the side panel with control panel on the seat.
- 3) Remove the legrests (see page 23).

**7.18.3 Preparing for transport**

127

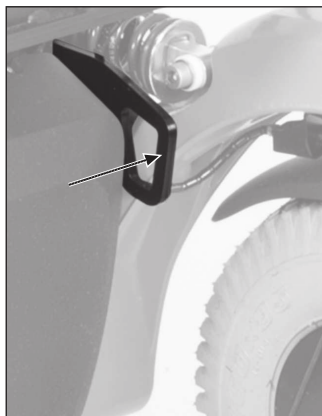
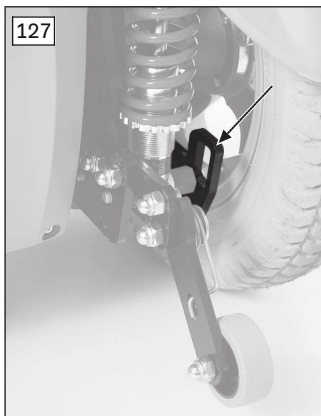
**Transporting the power wheelchair**

- 1) Position the power wheelchair in its transport location.
- 2) Turn the control unit off (see page 29 ff.).
- 3) Verify brake locking. It should not be possible to push the power wheelchair.  
**If needed:** Lock the brake (see page 61).
- 4) Use the eyebolts and cargo straps to attach the power wheelchair to the transport vehicle (see arrows).

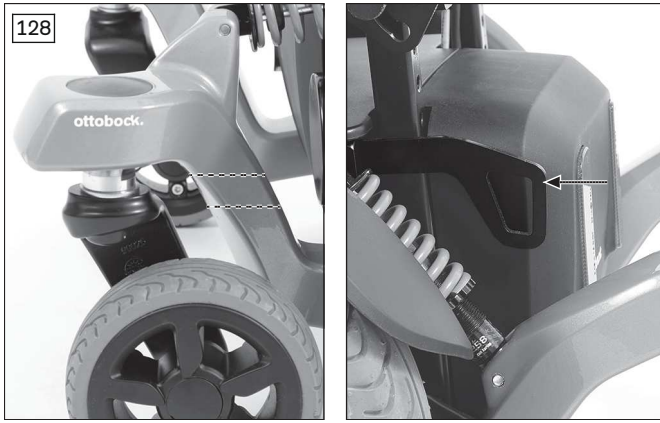

### Transporting the power wheelchair

- 1) Position the power wheelchair in its transport location.
- 2) Turn the control device off (see page 29 ff.).
- 3) Verify brake locking. It should not be possible to push the power wheelchair.  
**If needed:** Lock the brake (see page 61).
- 4) Use cargo straps to attach the power wheelchair to the transport vehicle. To do so, use the eyebolts on the frame (see fig. 128, right) and the opposite caster wheel swing arms (see fig. 128, left).  
**INFORMATION: Place respectively 2 x one belt loop around each caster wheel swing arm in the marked area.**

## 7.19 Use in vehicles for transporting persons with reduced mobility

### ⚠ WARNING

#### Use in vehicles for transporting persons with reduced mobility

Serious injuries in case of accidents due to user error

- ▶ Always use the seats and personal restraint systems in the vehicle for transporting persons with reduced mobility first. This is the only way to ensure optimum protection of passengers in the event of an accident.
- ▶ If the product is to be used as a seat in a vehicle for transporting persons with reduced mobility, the safety elements offered by the manufacturer and appropriate fastening and personal restraint systems must be used. For more information, please also refer to our brochure with the order number 646D158.
- ▶ Never transport more than one person in the power wheelchair.
- ▶ Note the approved climbing ability for driving on the ramp to the vehicle for transporting persons with reduced mobility (see the section "Technical data"). Also make sure that you can handle the product safely within the permissible conditions for use.
- ▶ Turn off the control device after positioning the power wheelchair in the vehicle for transporting persons with reduced mobility.
- ▶ Use the power wheelchair in a vehicle for transporting persons with reduced mobility only if the seat is all the way down and the back support is in a vertical position.
- ▶ Note the limitations regarding installed options (see page 121).

### ⚠ WARNING

#### Use of the belt system as a passenger restraint system in vehicles for transporting persons with reduced mobility is forbidden

Serious injuries due to improper handling of the product

- ▶ Under no circumstances may the belts and positioning aids offered with the product be used as part of a passenger restraint system in vehicles for transporting persons with reduced mobility.
- ▶ Note that the belts and positioning aids offered with the product are only intended to help support the user sitting in the product.

The product has been tested by the manufacturer according to ISO 7176-19 and may be used as a seat in vehicles for transporting persons with reduced mobility subject to the conditions defined below.

The product must be sufficiently secured during transport in vehicles for transporting persons with reduced mobility. The illustrations that follow show an example for anchoring in a motor vehicle.

The manufacturer is not responsible for the fastening systems that are used. Ensure that only fastening systems that meet the applicable legal requirements and are designed for the overall weight of the product including the user are used.

The transport weight of the person to be transported in a vehicle for transporting persons with reduced mobility corresponds to the maximum permissible user weight (see page 133).

### 7.19.1 Required accessories

Additional options must be installed to use the power wheelchair as a seat in a vehicle for transporting persons with reduced mobility. The qualified personnel who fitted the wheelchair can provide more information.

### Securing the product with fastening straps

The ISO sets listed below are available for securing with fastening straps.

**Please note:** All ISO sets are approved up to a max. load of **140 kg**.

- Mid-wheel drive, standard seat: 491S75=SK090
- Mid-wheel drive, VAS seat (mechanical back support angle adjustment): 491S75=SK092
- Mid-wheel drive, VAS seat (power back support angle adjustment): 491S75=SK093
- Mid-wheel drive, Recaro® seat: 491S75=SK093
- Front-wheel drive, VAS seat (mechanical back support angle adjustment): 491S75=SK094
- Front-wheel drive, VAS seat (power back support angle adjustment): 491S75=SK095
- Front-wheel drive, Recaro® seat: 491S75=SK095
- Front-wheel drive, standard seat: 491S75=SK096
- Rear-wheel drive, VAS seat (mechanical back support angle adjustment): 491S75=SK097
- Rear-wheel drive, VAS seat (power back support angle adjustment): 491S75=SK098
- Rear-wheel drive, Recaro® seat: 491S75=SK098
- Rear-wheel drive, standard seat: 491S75=SK099

### Securing the product with the Dahl docking system

When a standard seat or VAS seat is installed, the Ottobock "Dahl docking system" mounting kit is required for securing with the "Dahl docking system" option:

- Standard seat: 491S75=ST150
- VAS seat: 491S75=ST155

The corresponding adaptation set from Dahl and other components from the Dahl basic kit are also required. Further information is available from Dahl Engineering ApS, e-mail: [dahl@dahlengineering.dk](mailto:dahl@dahlengineering.dk), Internet: <https://dahlengineering.dk/en/>.

### 7.19.2 Using the product in a vehicle

#### **⚠ WARNING**

#### **Positioning in vehicles for transporting persons with reduced mobility**

Serious injuries in case of accidents due to user error

- ▶ Positioning of the product in vehicles for transporting persons with reduced mobility may only be performed by the qualified personnel.
- ▶ The product must always face forwards when it is used as a seat in a vehicle for transporting persons with reduced mobility.
- ▶ Instruct the qualified personnel regarding the mounting points on your product described below.

#### **⚠ WARNING**

#### **Inadequate transportation safety**

Loss of safe restraint due to failure to observe transportation instructions

- ▶ Observe the following instructions for correct transport safety in the vehicle for transporting persons with reduced mobility.
- ▶ If necessary, instruct the qualified personnel on the following information.

### Securing the product in the vehicle for transporting persons with reduced mobility

The wheelchair is secured in the vehicle for transporting persons with reduced mobility with the help of the fixation kit. The fixation points are marked with stickers. The stickers indicate where the user has to engage the hooks of the safety belt system:



### Securing the power wheelchair in the vehicle

- 1) Position the power wheelchair in the vehicle for transporting persons with reduced mobility. For more information, refer to section 5 in the brochure "Transporting persons with reduced mobility", order number 646D158.
- 2) Turn the control device off (see page 56).
- 3) Verify brake locking. Engage the brakes if needed (see page 61).
- 4) Attach the vehicle side wheelchair restraint belts (see next illustration).

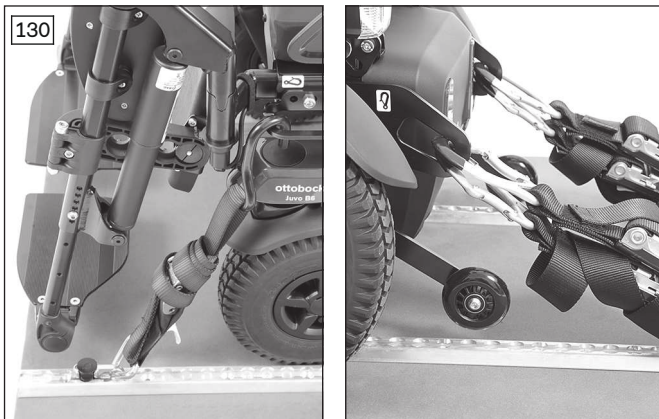

### Attaching vehicle side wheelchair restraint belts

- 1) Engage the hook of the vehicle side wheelchair restraint belt from the outside respectively in the front mounting eyes (see fig. 130, left).
- 2) Engage the hooks of the vehicle side wheelchair restraint belts **two times respectively** from the outside in the rear mounting eyes (see fig. 130, right).
- 3) Tighten the front and rear attachment straps as firmly as possible (see fig. 129).



### Securing the power wheelchair in the vehicle

- 1) Position the power wheelchair in the vehicle for transporting persons with reduced mobility. For more information, refer to section 5 in the brochure "Transporting persons with reduced mobility", order number 646D158.
- 2) Turn the control device off (see page 56).
- 3) Verify brake locking. Engage the brakes if needed (see page 61).
- 4) Attach the vehicle side wheelchair restraint belts (see next illustration).

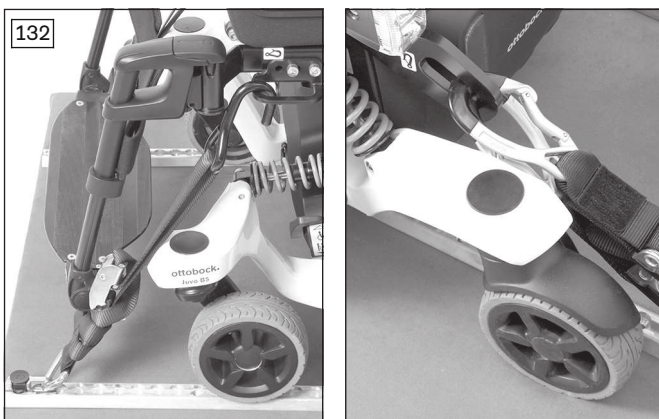

### Applying the attachment straps

- 1) Engage the hook of the vehicle side wheelchair restraint belt from the outside respectively in the front mounting eyes (see fig. 132, left).
- 2) Engage the hooks of the vehicle side wheelchair restraint belts **two times respectively** from the outside in the rear mounting eyes (see fig. 132, right).
- 3) Tighten the front and rear attachment straps as firmly as possible (see fig. 131).



### Information on correct transport safety of the user in the vehicle for transporting persons with reduced mobility

- Using the personal restraint system of the vehicle for transporting persons with reduced mobility is required. Attaching personal restraint systems of the vehicle for transporting persons with reduced mobility to the wheelchair is not permitted. The three-point restraint has to be realised entirely on the vehicle:
  - The lap belt of the personal restraint system is usually attached at the rear on both sides on the vehicle bottom with the help of a belt reel or retractor (seat belt tightener).
  - The shoulder harness of the personal restraint system is usually mounted on the vehicle pillar and is attached by the qualified personnel to the corresponding mounting point/pin provided on the lap belt.

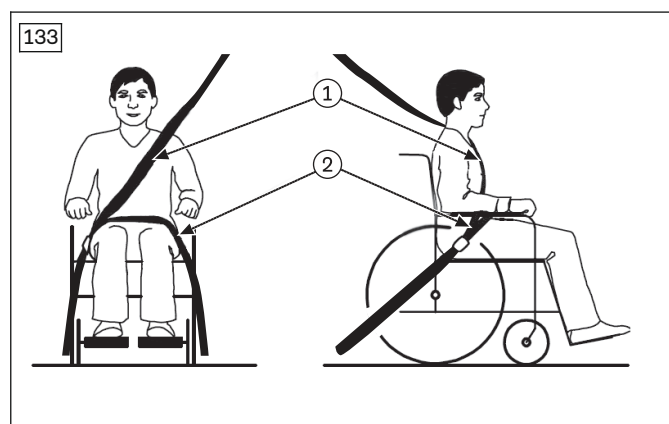

- The straps of the personal restraint system must always be routed close to the user's body. The straps must not be routed over the side panels and wheels (see fig. 133 item 2).
- The shoulder harness must always be routed over the user's shoulder. The qualified personnel must secure the shoulder harness above and behind the user (see fig. 133, item 1).
- The belt strap must not be twisted on the user's body.
- The wheelchair restraint belts secured to the vehicle floor must be stretched as taut as possible once they are attached.

### Placement of the personal restraint system integrated in the vehicle for transporting persons with reduced mobility

- Pull each end of the restraint lap belt from the inner side of the seat through to the outside.
  - Attach each of the ends of the restraint lap belt on the vehicle bottom in the manner described above.  
**INFORMATION: The power wheelchair's lap belt should be used in addition to position the passenger during transportation.**
  - Secure the shoulder harness above and behind the user.
- The four-point belt can be used in addition to position the passenger during transportation.

#### 7.19.3 Restrictions for use

##### **⚠ WARNING**

##### **Risk of accidents and injury due to using the product with certain settings and/or installed options**

Severe injury in case of accidents due to options coming loose

- Before using the product as a seat in a vehicle for transporting persons with reduced mobility, remove options that need to be taken off for safe transportation. Please observe the following table.
- Stow all dismantled components securely in the vehicle for transporting persons with reduced mobility.
- Please note that certain settings on the product exclude the use of the product in a vehicle for transporting persons with reduced mobility.

Options*	Transportation in a vehicle for transporting persons with reduced mobility not possible	Option must be removed	Secure option on product
ADI back support (Baxx line)	X**		
Tray, swing-away to the side		X	
Mid-tray control, swing-away to the right or left		X	
Lap belt with buckle			X***
Four-way chest strap kit, static			X****
Luggage carrier			X

\* The following list provides an overview. Not all options are installed on all products.

\*\* Only in combination with 4-point holder

\*\*\* The belt should be used to position the passenger during transportation. Using the personal restraint system is nevertheless required.

\*\*\*\* The belt can be used to position the passenger during transportation. Using the personal restraint system is nevertheless required.

Special control (version*)	Transportation in a vehicle for transporting persons with reduced mobility not possible	Option must be removed	Secure option on product
Sip and puff control (standard control panel included)			X
Chin control with mini joystick, power swing-away			X
Chin control with midi joystick, power swing-away			X

\* The following list provides an overview of all versions of the special control that cannot be used.

### 7.19.4 Prohibited use

**⚠ WARNING**

**Improper use in vehicles for transporting persons with reduced mobility**  
 Risk of serious injury when using the product as a seat

- ▶ Please note that certain optional components on the product exclude the use of the product in a vehicle for transporting persons with reduced mobility.
- ▶ If the prohibition symbol shown below appears on the nameplate, this means the following: In vehicles for transporting persons with reduced mobility, only use the seats installed in the vehicle with the corresponding personal restraint systems.
- ▶ Information on the current status of our measures is available from the qualified personnel.

 If the adjacent symbol appears on the nameplate, this indicates the following:  
 The product may **not** be used as a seat in vehicles for transporting persons with reduced mobility.

## 7.20 Care

### 7.20.1 Safety instructions

**⚠ CAUTION**

**Lack of or improper cleaning**  
 Health hazard due to infections, damage to the product due to user error

- ▶ Clean the product at regular intervals.
- ▶ Water must not come into direct contact with the electronics, motor or batteries under any circumstances during cleaning. Never use a water jet or high-pressure cleaning apparatus to clean the product.
- ▶ To avoid contamination with germs, clean seat cushions and back support upholstery whenever they get soiled.
- ▶ Check the driving behaviour of the product after cleaning it.

**INFORMATION**

Piston rods do not require lubrication. They are maintenance-free.

### 7.20.2 Cleaning

Clean the product regularly depending on the degree of soiling and frequency of use, **at least 1x per month**:

- Clean the control panel, battery charger, armrest and trim components with a damp cloth and mild cleaning solution.
- Use a dry brush to clean the seat and back upholstery as well as the seat cushion.
- For more information on cleaning seat cushions, see the care instructions on the product or the supplied instructions for use.

- Use a damp plastic brush to clean the wheels and frame.
- Do not use any aggressive cleaners, solvents or hard brushes etc.
- Do not spray the product with a pressure washer.
- Additional notices for cleaning the sip and puff control: see page 101.

### 7.20.3 Disinfection

- 1) Thoroughly clean the pads before disinfecting.
- 2) Wipe all parts of the product with a disinfectant.

#### Important information about disinfecting

- Only use colourless water-based disinfectants. Observe the instructions for use provided by the manufacturer.
- Prior to disinfection, clean the seat and back padding, control panel and armrests.

## 8 Maintenance and repair

### 8.1 Maintenance

#### WARNING

##### Insufficient maintenance

Severe user injuries, damage to the product due to failure to observe maintenance intervals

- ▶ Only carry out the maintenance tasks described in this section. All other maintenance and service tasks may only be carried out by qualified personnel.
- ▶ The functionality and operating safety of the product must be verified and a service performed at least **once per year**.
- ▶ For users with a changing anatomy (for example body dimensions, weight) or users with a changing clinical picture, have the product inspected, adjusted and serviced at least **once every six months**.

#### WARNING

##### Failure to inspect important product features

Severe user injuries, damage to the product due to maintenance errors

- ▶ Inspect the seat adjustment features for visible signs of damage at least **1 x per month** and ensure all screw connections are tight.
- ▶ Maintain sufficient air pressure in the tyres. The correct tyre pressure is printed on the tyre casing and listed in the section "Technical data".

- The function of the product should be checked **before each use**.
- The product may not be used if defects are noted. This applies in particular in case of instability of the product or altered driving characteristics as well as problems with the user's seating position or the stability of the seat. Inform the qualified personnel promptly for the rectification of defects.
- This also applies if loose, worn, bent or damaged components, cracks in the frame or broken frame components are identified.
- Some maintenance tasks can be carried out to a specified extent by the user at home. Further information is found in the section "Maintenance intervals" (see page 123).
- Failure to maintain the product can lead to injuries for the user of the product.

#### 8.1.1 Maintenance intervals

The functions described below must be checked by the user or an attendant at the specified intervals:

Component	Task	Prior to every use	Weekly	Monthly
Drive wheels	Check that wheel mounts are securely fastened			X
	Check that wheels rotate freely and without axial runout			X
	Check directional stability of the power wheelchair	X		
Caster wheels	Check that the fork is seated in the adapter without play			X
	Check that wheels rotate freely and without axial runout			X
	Check that the mounting nuts are tight			X
Seat attachment	Check that mounting screws are fastened properly			X
	Check that seat lock is positioned securely	X		

Component	Task	Prior to every use	Weekly	Monthly
Leg support	Check that mounting screws are fastened properly (check tightening torque)			X
	Check ratchet mechanism for functionality and firm fit			X
	Check for damage to foot supports			X
	Check whether the foot supports are sufficiently stable in the folded-up position			X
Padding/belts	Ensure that padding is in perfect condition			X
	Check the fastening straps for wear			X
	Check functionality of belt buckle		X	
Tyres	Check air pressure (see tyre sidewall)			X
	Check for sufficient tread depth (min. 1 mm/0.04")			X
	Check for damage			X
Batteries	Check battery charge level	X		
Lights	Check for external damage		X	
	Verify functionality	X		
Electronics	Check that the control device is functioning properly (inform qualified personnel of any error messages on the control panel)	X		
	Check that the battery charger is functioning properly (inform qualified personnel of any LED error messages)		X	
	Check plug connections			X
Brake	With brake disengaged: check whether the indicator on the control panel is flashing	X		
	With brake engaged: check the braking function by trying to push the wheelchair			X
Seat adjustment functions	Visually inspect all moving components and cabling for damage			X
	Check that screw connections are tight			X
Side panel and arm support	Check that mounting screws are fastened properly			X
	Check that screw connections between the arm support and the control panel are tight	X		
	Check arm support for damage		X	
Gas compression spring or actuator	Visual inspection for scratches and oil leaks on the piston rod			X
Product	Check the legibility and completeness of all labels and markings on the product			X

### Special control maintenance tasks

The proper functionality of the respective special control must be verified each time before the wheelchair is used. The actions described in the following table should be performed at the specified intervals either by the user or the attendants.

Component	Task	Prior to every use	Weekly
Control device as a whole	Verify proper functionality: verify function of buttons, verify function of special control components	X	
Joystick control	Automatic reset to mid-position (neutral position)	X	
Wear and tear parts (e.g. tubes of sip and puff control)	Visual inspection		X
Mechanical attachment of the control device			X

Component	Task	Prior to every use	Weekly
	Check that the movable parts of the control device are properly fixed		
Screw connections	Check for firm fit		X

## 8.2 Repair

### ⚠ WARNING

#### Prohibited repairs

Severe user injuries, damage to the product due to adjustment and installation errors

- ▶ Only carry out the repairs described in this section. All other repairs may only be carried out by the qualified personnel.

### 8.2.1 Replacing defective lights

#### NOTICE

#### Use of incorrect bulbs

Damage/melting of the connecting cables due to excess current flow

- ▶ Note that the LED lighting may only be replaced with original lighting.

The LED lighting is maintenance-free. If repairs are required, the qualified personnel who fitted or delivered the wheelchair can help.

### 8.2.2 Replacing the battery

Batteries may only be replaced by qualified personnel.

## 8.3 Troubleshooting

### INFORMATION

In the event of communication problems in the bus system of the controls, the system triggers an emergency stop and thus prevents any uncontrolled functions.

- ▶ Note that after every emergency stop, you have to turn the power wheelchair control unit on again.
- ▶ If the driving function is still not available after turning the control unit on again, activate pushing mode by releasing the brake.
- ▶ Inform the qualified personnel immediately.

Faults are displayed on the LED display fields on the control panel. The following table shows the individual notifications as well as the associated fault sources and possible causes and measures.

Qualified personnel should be contacted if the measures described here do not resolve the faults completely. Qualified personnel can read the exact error codes with a handheld programming device and can perform a targeted system analysis.

The control device stores all errors that have occurred in a list. The qualified personnel reads this information, for example during a general overhaul of the power wheelchair. The qualified personnel determines future service and maintenance intervals based on the saved data.

Faults are indicated on the control panel LCD screen, on the LCD monitor (if installed) or on the attendant control (if installed). The following table shows the individual notifications as well as the associated fault sources and possible causes and measures.

If the measures described here do not resolve the faults completely, contact your specialist dealer. The specialist dealer is able to read the exact error codes with a handheld programming device and can perform a targeted system analysis.

The control unit stores a list of all faults that occur. The specialist dealer reads this information, for example during a general overhaul of the power wheelchair. Based on the saved data, the specialist dealer determines future service and maintenance intervals.

### 8.3.1 Types of notifications

#### Warning

A warning indicates a status or malfunction of one or several components of the power wheelchair. The function of components without errors is not restricted.

For example, if the connection between the control unit and seat motor is faulty, this error will only be indicated if the user attempts to activate the motor. However, the driving function is still available.

**Error**

An error affects one or several functions of the power wheelchair. The power wheelchair and its functions are not fully operational until the fault is resolved.

**Structure of an error message**

The control device display shows both errors in the control system itself as well as errors in electrical components of the power wheelchair or errors in the cabling. The error message contains the following information:

- Affected module – e.g. JSM = joystick module (control panel); PM = power module (control device), Omni Display (display module), Omni IO (connection module)
- Error code (4 characters)
- Abbreviated error description





**8.3.2 Procedure for warnings and error messages**



- If a warning or error message appears, the power wheelchair can often no longer be driven. In this case, the error message must be noted, the control unit switched off and the qualified personnel informed of the error message immediately.
- If the error is related to a component which is not currently being used (e.g. to an actuator for adjusting the seat function), the driving function of the power wheelchair is still theoretically usable. An error message simply appears at regular intervals.
- Nonetheless, the control unit **must** be switched off for several minutes in this case. If the error message continues to appear after switching on the control unit, the error message **must** be noted, the control unit switched off again and the qualified personnel informed of the error message immediately.

**8.3.3 Wheelchair control unit error overview**

<b>INFORMATION</b>
Depending on the version or country-specific equipment, the list of relevant error messages may deviate from the overview provided here.

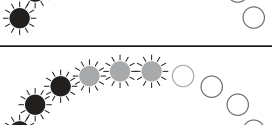
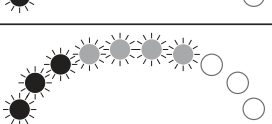
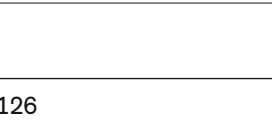
**VR2 control panel**

Flashing LED	Error/warning	Cause	Possible corrective action
	Battery undervoltage	Battery deep discharge Battery cable malfunctioning or faulty connection to the battery	Charge as soon as possible Check the connection to the battery (charge the battery if the connection is good)
	Left motor not connected	e.g. defective plug connection, cable break	Check plug connections and cable to left motor
	Wiring fault on the left motor	e.g. cable break, no connection to battery	Check cable connections to left motor; check connection to battery terminal
	Right motor not connected	e.g. defective plug connection, cable break	Check plug connections and cable to right motor
	Defective cables on right motor	e.g. cable break, no connection to battery	Check cable connections to right motor; check connection to battery terminal
	Driving function blocked due to external factors	Battery charger may be connected	Disconnect battery charger
	Joystick fault	Joystick not in home position when the unit is turned on	Move the joystick to the home position before switching the unit on

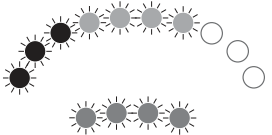



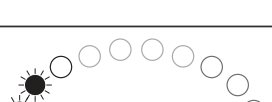
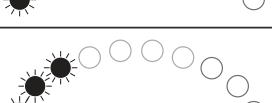
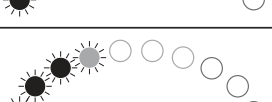
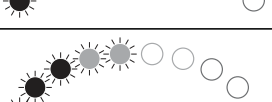
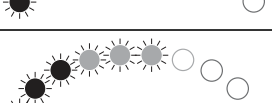
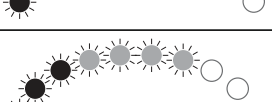
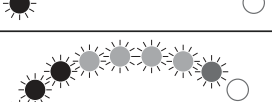
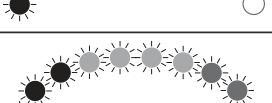
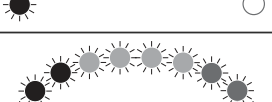
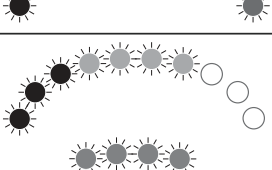

Flashing LED	Error/warning	Cause	Possible corrective action
	Controller fault	Defective controller	Check all connections
	Brake release	Open brake release	Check motor brakes Check connection to the controller
	Battery overvoltage	Voltage too high Loose battery contacts	Continue driving slowly Check cabling/plug contacts
	Communication error between control panel (joystick) and controller	Defective cable, loose plug connection	Check cabling/plug contacts

**JSM-LED-L control panel**

Flashing LED	Error/warning	Cause	Possible corrective action
	Battery undervoltage	Battery deep discharge Battery cable malfunctioning or faulty connection to the battery	Charge as soon as possible Check the connection to the battery (charge the battery if the connection is good)
	Left motor not connected	e.g. defective plug connection, cable break	Check plug connections and cable to left motor.
	Wiring fault on the left motor	e.g. cable break, no connection to battery	Check cable connections to left motor; check connection to battery terminal
	Right motor not connected	e.g. defective plug connection, cable break	Check plug connections and cable to right motor
	Defective cables on right motor	e.g. cable break, no connection to battery	Check cable connections to right motor; check connection to battery terminal
	Driving function blocked due to external factors	Battery charger may be connected	Disconnect battery charger
	Joystick fault	Joystick not in home position when the unit is turned on	Move the joystick to the home position before switching the unit on
	Controller fault	Defective controller	Check all connections
	Brake release	Brake disabled	Check motor brakes Check connection to the controller
	Battery overvoltage	Voltage too high Loose battery contacts	Continue driving slowly Check cabling/plug connections
	Communication error between control panel (joystick) and controller	Defective cable, loose plug connection	Check cabling/plug connections

Flashing LED	Error/warning	Cause	Possible corrective action
	Fault on an actuator (seat function adjustment motor)	e.g. defective cable, loose plug connection to actuator	Check cabling/plug connections to defective actuator

**TEN° control panel; TEN° LCD module**

Display	Error/warning	Cause	Possible action
	Emergency stop	Serious controller/handheld control device and/or drive motor malfunction	Check cabling/plug contacts Contact qualified personnel
	Joystick warning (Center Joystick)	Joystick not in neutral position when the unit is turned on	Move the joystick to the neutral position before switching the unit on
	Defective joystick (Joystick Error)	Message continues to be displayed despite moving joystick to centre position	Contact qualified personnel
	Message window for serious errors	Causes of the respective error messages: see following table	Actions for the respective error messages: see following table
	Message window for warnings (Error message examples: see next two lines)	Causes of the respective warning messages: see following table	Actions for the respective warning messages: see following table
	Controller temperature warning (lights up red)	Overheating due to excessive load	Cool down phase
	Motor temperature warning (lights up red)	Overheating due to excessive load	Cool down phase

**Errors and warning messages in the message window on the TEN° control panel or TEN° LCD module**

Error message	Error no.	Contents	Cause	Possible action
Center Joystick	See previous table			
Joystick Error	See previous table			
Low Battery	(None)	Battery undervoltage	Battery deep discharge	Charge as soon as possible
High Battery	(None)	Battery overvoltage	Voltage too high Loose battery contacts	Continue driving slowly Check cabling/plug connections; if error persists, contact qualified personnel
M1 Brake Error	1505	Brake error on left motor	e.g. defective plug connection, cable	Check plug connections and cable to
M2 Brake Error	1506	Brake error on right motor	break Defective brake	brake



Error message	Error no.	Contents	Cause	Possible action
				If error persists, contact qualified personnel
M1 Motor Error	3B00	Left motor not connected	e.g. defective plug connection, cable break	Check plug connections and cable to motor
M2 Motor Error	3C00	Right motor not connected		
Inhibit Active	1E01; 1E20; 1E21; 1E22; 1E23	Driving function blocked due to external factors	Battery charger may be connected	Disconnect the battery charger
Brake Lamp Short	(None)	Short circuit in brake light electrical circuit	e.g. defective plug connection, cable break Defective brake light	Check plug connections and cable to brake light If error persists, contact qualified personnel
Left Lamp Short	7205	Short circuit in electrical circuit of left front/rear light	e.g. defective plug connection, cable break	Check plug connections and cable to front/rear light
Right Lamp Short	7209	Short circuit in electrical circuit of right front/rear light	Defective front/rear light	If error persists, contact qualified personnel
L Ind Lamp Short	7206	Short circuit in electrical circuit of left direction indicator	e.g. defective plug connection, cable break	Check plug connections and cable to direction indicator
R Ind Lamp Short	720A	Short circuit in electrical circuit of right direction indicator	Defective direction indicator signal	If error persists, contact qualified personnel
L Ind Lamp Failed	7207	Error in electrical circuit of left direction indicator	e.g. defective plug connection, cable break	Check plug connections and cable to direction indicator
R Ind Lamp Failed	7208	Error in electrical circuit of right direction indicator	Defective bulb	If error persists, contact qualified personnel
Over-current	(None)	Amount of current in an actuator circuit too great	e.g. defective plug connection, cable break Defective servomotor (actuator) or controller	Check plug connections and cable to servomotor; ensure free movement of the actuating drive If error persists, contact qualified personnel
Overtemp. (Acts)	(None)	Temperature on actuator circuits on controller too high	e.g. defective plug connections Defective servomotor (actuator)	Cool down phase Check plug connections and cable to actuator If error recurs, contact qualified personnel
Overtemp. (Lamps)	(None)	Temperature on the light circuit on the controller too high	e.g. defective plug connections Defective lamp	Cool down phase Check plug connections and cable to light If error recurs, contact qualified personnel

<b>Error message</b>	<b>Error no.</b>	<b>Contents</b>	<b>Cause</b>	<b>Possible action</b>
Memory Error	(None)	Unspecified memory error in control modules	e.g. defective plug connection, cable break Defective control module	Contact qualified personnel
PM Memory Error	(None)	Memory error in controller	e.g. defective plug connection, cable break Defective controller	Check all plug connections and cables on controller If error persists, contact qualified personnel
Bad Cable	(None)	Error on the communication cables between control modules	e.g. defective plug connection, cable break	Check all plug connections and cables on the control modules (incl. controller) If error persists, contact qualified personnel
Module Error	(None)	Error in control modules	e.g. unspecified error in displayed control module Displayed control module defective	Check all plug connections and cables If error persists, contact qualified personnel
System Error	(None)	System error	Non-attributable error in control modules (primarily from third-party providers)	Check all plug connections and cables; disconnect/test any modules from third-party providers in succession if applicable If error persists, contact qualified personnel
SID Detached	(None)	Special control disconnected	Special control disconnected from the connection module of the TEN° LCD module (sip and puff control) Defective special control connection on the connection module of the TEN° LCD module	Check all plug connections and cables between special control connection and sip and puff control; check programming parameters If error persists, contact qualified personnel
Switch Detached	1E07	External on/off switch disconnected from control panel	e.g. defective cable connection to control panel	Check cable connection and switching function of the external switch If error persists, contact qualified personnel
	1E08	External profile/mode switch disconnected from control panel	Defective switch or control panel	
Gone to Sleep	(None)	Control device switches to sleep mode	Extended inactivity while control device is switched on	Switch control device off/on
Charging	(None)	Battery charger is connected	Battery charger is connected to charging receptacle	Disconnect battery charger prior to driving

Error message	Error no.	Contents	Cause	Possible action
JS Static Timeout	(None)	Joystick holding time exceeded	Excessive joystick deflection detected (control device stops drive system to prevent potential damage to the motors) Defective joystick	Switch control device off/on If error persists: replace control panel/joystick; contact qualified personnel
Switch Short	1E0D	Short circuit on external on/off switch	e.g. defective cable connection to control panel	Check cable connection and switching function of the external switch If error persists, contact qualified personnel
	1E0C	Short circuit on external profile/mode switch	Defective switch or control panel	

#### Additional error messages for model equipped with a gyro module



Error message	Error no.	Contents	Cause	Possible action
Gyro Disconnected	(None)	Electronic track stabiliser (gyro module) disconnected from controller	e.g. defective cable connection to controller Defective gyro module	Contact qualified personnel
Gyro Prf Active	(None)	Electronic track stabiliser (gyro module) is activated	Electronic track stabiliser (gyro module) is disrupted by the movement of a different means of transportation (e.g. train, ship) in standby Defective gyro module	When driving/standing in means of transportation, select the "No Assist" driving profile for safety reasons If error persists, contact qualified personnel

#### Additional error messages for model equipped with an ASM module

Error message	Error no.	Contents	Cause	Possible action
Orientation Error	(None)	Orientation error on advanced stability module (ASM)	Defective advanced stability module (ASM)	Contact qualified personnel
ASM Disconnected	(None)	Advanced stability module (ASM) disconnected from controller	e.g. defective plug connection, cable break Defective advanced stability module (ASM)	Contact qualified personnel





### 8.3.4 Attendant control error overview

#### VR2 attendant control

Flashing LED	Error/warning	Cause	Possible measure
	Control unit fault	Fault in the control unit	Read error on the control panel and take corresponding action (see "Wheelchair control unit error overview" table)
	Attendant control fault	Defective attendant control	Switch off attendant control and turn control panel off/on
	Joystick error	Attendant control joystick not in home position when the unit is turned on	Switch off attendant control and move joystick to home position before switching the unit on

Flashing LED	Error/warning	Cause	Possible measure
			Switch control panel off/on
	Communication error between the attendant control (joystick) and the control panel/controller	Defective cable, loose plug connection	Check cabling / plug connections

### R-Net attendant control

Flashing LED	Error/warning	Cause	Possible measure
	Control unit fault	Fault in the control unit	Read error on the control panel and take corresponding action (see "Wheelchair control unit error overview" table)
	Attendant control fault	Defective attendant control	Switch off attendant control and turn control panel off/on
	Joystick error	Attendant control joystick not in home position when the unit is turned on	Switch off attendant control and move joystick to home position before switching the unit on Switch control panel off/on
	Communication error between the attendant control (joystick) and the control panel/controller	Defective cable, loose plug connection	Check cabling / plug connections

## 8.4 Behaviour in case of breakdowns

### INFORMATION

Note that the following instructions also apply for flat tyres. Independent tyre repairs by the user or an attendant are not intended.

In case of breakdowns, promptly inform the qualified personnel who adjusted the product or the manufacturer's service (see inside or outside of back cover for addresses). All relevant details have to be provided, such as the type of power wheelchair, type of breakdown (e.g. problems with the motor) and if possible, the serial number of the power wheelchair.

To get help faster, noting the address and telephone number of the qualified personnel in the field provided on the back of these instructions for use is recommended. This information should be kept on hand, especially when driving outdoors.

## 9 Disposal

### 9.1 Safety instructions

#### NOTICE

#### Disposal of batteries

Pollution due to incorrect disposal

- ▶ Observe the information printed on the batteries by the manufacturer.
- ▶ Note that the batteries may not be disposed of as household waste.

### 9.2 Disposal information

Return the product to the qualified personnel for disposal.

Defective batteries are taken back by the qualified personnel in exchange when new batteries are purchased.

All components of the product must be disposed of properly in accordance with the respective national environmental regulations.

## 10 Legal information

All legal conditions are subject to the respective national laws of the country of use and may vary accordingly.

### 10.1 Liability

The manufacturer will only assume liability if the product is used in accordance with the descriptions and instructions provided in this document. The manufacturer will not assume liability for damage caused by disregarding the information in this document, particularly due to improper use or unauthorised modification of the product.

### 10.2 Warranty

Further information on the warranty terms and conditions can be obtained from the qualified personnel that has fitted this product or the manufacturer's service (see inside back cover for addresses).

### 10.3 Privacy notice

Some components of the product contain data storage modules that temporarily or permanently store data. These data are exclusively of a technical nature and serve the safety of the user, the identification and elimination of errors and/or optimising the functionality of the product.

Depending on the model and version, malfunctions and faults of components relevant for safety as well as status messages of individual components are recorded. The data are available in anonymised/pseudonymised form when the data storage modules are read in case of service. Ottobock stores, processes and uses the data according to the applicable data protection regulations.

For detailed questions please contact: [datenschutz@ottobock.de](mailto:datenschutz@ottobock.de). For questions regarding treatment, please contact the qualified personnel.

### 10.4 Lifetime

Expected lifetime: **5 years**

The design, manufacturing and requirements for the intended use of the product are based on the expected lifetime. These also include the requirements for maintenance, ensuring effectiveness and the safety of the product.

## 11 Technical data

### INFORMATION

- ▶ Much of the technical data below is given in mm. Please note that product settings – unless otherwise specified – cannot be adjusted in the mm range but only in increments of approx. **0.5 cm** or **1 cm**.
- ▶ Note that the values achieved during adjustment may deviate from the values specified below. The deviation can be **±10 mm** and **±2°**.

### INFORMATION

The following tables may contain technical data that do not apply to your product due to the selected configuration.

#### Application class (according to DIN EN 12184)

Class A

#### Application class (according to DIN EN 12184)

Class B

#### Drive type

Front-wheel drive

#### Drive type

Rear-wheel drive

#### Drive type

Mid-wheel drive

#### Mobility base

Size 1

#### Mobility base

Size 2

<b>Weight (minimum/maximum)*</b>	
Minimum weight	100 kg (220 lbs)
Maximum weight	200 kg (441 lbs)

<b>Weight*</b>	
Equipped with mobility base 1 + standard seat	from 110 kg (from 242.5 lbs)

<b>Weight*</b>	
Equipped with mobility base 2 + standard seat	from 125 kg (from 275.5 lbs)

\* The product weight varies depending on the equipment selected.

<b>Weight*</b>	
Equipped with mobility base 1 + VAS seat	from 115 kg (from 253.5 lbs)

<b>Weight*</b>	
Equipped with mobility base 2 + VAS seat	from 130 kg (from 286.5 lbs)

\* The product weight varies depending on the equipment selected.

<b>Load</b>	
Maximum load (User weight + luggage)	140 kg (308.6 lbs); the load is reduced depending on equipment

<b>Load</b>	
Maximum load (User weight + luggage)	160 kg (352.7 lbs); the load is reduced depending on equipment

<b>Load</b>	
Maximum load (User weight + luggage)	180 kg (397 lbs); the load is reduced depending on equipment

<b>Load</b>	
Maximum load (User weight + luggage)	200 kg (440.9 lbs); the load is reduced depending on equipment

**Please note:** With a standard seat Junior, the maximum load is reduced to 75 kg (165 lbs).

<b>Dimensions – standard seat Junior</b>	
Effective seat depth*	340–400 mm (13.4"–15.7")
Effective seat width*	340–400 mm (13.4"–15.7")
Anterior seat height*	410–570 mm (16.1"–22.4")
Lower leg length**	150–540 mm (5.9"–21.2")
Back support height	370/420/470 mm (14.6"/16.5"/18.5")
Arm support height (telescoping arm support)	185–225 mm (7.3"–8.8")

\* In increments of 20 mm

\*\* In increments of 10 mm

<b>Dimensions – standard seat, small</b>	
Effective seat depth*	380–460 mm (15"–18.1")
Effective seat width*	380–420 mm (15"–16.5")
Anterior seat height*	410–570 mm (16.1"–22.4")
Lower leg length**	150–540 mm (5.9"–21.2")
Back support height	450/500/550 mm (17.7"/19.7"/21.6")
Arm support height (telescoping arm support)	205–275 mm (8.1"–10.8")

\* In increments of 20 mm

\*\* In increments of 10 mm

<b>Dimensions – standard seat, large</b>	
Effective seat depth*	420–500 mm (16.5"–19.7")
Effective seat width*	440–480 mm (16.9"–18.9")
Anterior seat height*	410–570 mm (16.1"–22.4")
Lower leg length**	150–540 mm (5.9"–21.2")
Back support height	450/500/550 mm (17.7"/19.7"/21.6")
Arm support height (telescoping arm support)	205–275 mm (8.1"–10.8")

\* In increments of 20 mm

\*\* In increments of 10 mm

<b>Dimensions – standard seat, XL</b>	
Effective seat depth*	420–500 mm (16.5"–19.7")
Effective seat width*	500–560 mm (19.7"–22")
Anterior seat height*	410–570 mm (16.1"–22.4")
Lower leg length**	150–540 mm (5.9"–21.2")
Back support height	450/500/550 mm (17.7"/19.7"/21.6")
Arm support height (telescoping arm support)	205–275 mm (8.1"–10.8")

\* In increments of 20 mm

\*\* In increments of 10 mm

**Note:** Due to certain restrictions in the configuration, the actual front seat height deviates from the selected seat height by +/- 10 mm.

<b>Dimensions – VAS seat (all types)</b>	
Effective seat depth*	380–580 mm (14.6"–22.8")
Effective seat width*	380–540 mm (15"–21.3")
Anterior seat height**	430–570 mm (16.9"–22.4")
Lower leg length***	150–540 mm (5.9"–21.3")
Back support height	450/510/530/550 mm (17.7"/20"/20.8"/21.6")
Arm support height (telescoping arm support)	185–255 mm (7.3"–10")

\* Continuous

\*\* In increments of 20 mm

\*\*\* In increments of 10 mm

<b>Dimensions – Recaro® seat</b>	
Effective seat depth	380–560 mm (15"–22.8")
Seat width*	Inside: 320–340 mm (12.6"–13.4") Outside: 450–480 mm (17.7"–18.9")
Seat height**	410–570 mm (16.1"–22.4")
Lower leg length	280–540 mm (11"–21.2")
Back height	620 mm (24.4")

\* Inner seat width = effective seat width

\*\* In increments of 20 mm

<b>Dimensions and weights (front-wheel drive; mobility base = size 1)*</b>	
Overall width (standard motor/performance or high performance motor)**	596 / 612 mm (23.5" / 24.1")
Overall height (equipped with standard seat)	850–1,110 mm (33.4"–43.7")
Overall height (equipped with VAS seat)	850–1,110 mm (33.4"–43.7")
Overall length (without leg support)	908 mm (35.75")
Overall length (with leg support)	Minimum: 1050 mm (41.3"); maximum: 1250 mm (49.2")
Arm support length (standard)	260 mm (10.2")

<b>Dimensions and weights (front-wheel drive; mobility base = size 1)*</b>	
Foremost point of the side panel (measured to back support)	Minimum: 300 mm (11.8"); maximum: 580 mm (22.8")
Transport weights***	See "Weight", of this, weight of removable components: Leg support (standard): approx. 2.2 kg (4.9 lbs) Detachable side panel: approx. 3 kg (6.6 lbs) Leg support (power, with aluminium foot plate): approx. 6.5 kg (14.3 lbs)
Minimum turning radius	965 mm (38")
Ground clearance	80 mm
Caster wheel tyre size	9"/10"
Drive wheel tyre size	14"

<b>Dimensions and weights (front-wheel drive; mobility base = size 2)*</b>	
Overall width (standard motor/performance or high performance motor)**	626 / 642 mm (24.6" / 25.3")
Overall height (equipped with standard seat)	850–1,110 mm (33.4"–43.7")
Overall height (equipped with VAS seat)	850–1,110 mm (33.4"–43.7")
Overall length (without leg support)	968 mm (38.1")
Overall length (with leg support)	Minimum: 1050 mm (41.3"); maximum: 1250 mm (49.2")
Arm support length (standard)	260 mm (10.2")
Foremost point of the side panel (measured to back support)	Minimum: 300 mm (11.8"); maximum: 580 mm (22.8")
Transport weights***	See "Weight", of this, weight of removable components: Leg support (standard): approx. 2.2 kg (4.9 lbs) Detachable side panel: approx. 3 kg (6.6 lbs) Leg support (power, with aluminium foot plate): approx. 6.5 kg (14.3 lbs)
Minimum turning radius	965 mm (38")
Ground clearance	80 mm
Caster wheel tyre size	9"/10"
Drive wheel tyre size	14"

\* Depending on equipment selected

\*\* May be larger due to seat width adjustment. Overall width +180 mm in the assembled state.

\*\*\* Weight of the heaviest component

<b>Dimensions and weights (rear-wheel drive; mobility base = size 1)*</b>	
Overall width (standard motor/performance or high performance motor)**	596 / 612 mm (23.5" / 24.1")
Overall height (equipped with standard seat)	850–1,110 mm (33.4"–43.7")
Overall height (equipped with VAS seat)	850–1,110 mm (33.4"–43.7")
Overall length (without leg support)	850 mm (33.5")
Overall length (with leg support)	Minimum: 1050 mm (41.3"); maximum: 1250 mm (49.2")
Arm support length (standard)	260 mm (10.2")
Foremost point of the side panel (measured to back support)	Minimum: 300 mm (11.8"); maximum: 580 mm (22.8")
Transport weights***	See "Weight", of this, weight of removable components: Leg support (standard): approx. 2.2 kg (4.9 lbs) Detachable side panel: approx. 3 kg (6.6 lbs) Leg support (power, with aluminium foot plate): approx. 6.5 kg (14.3 lbs)
Minimum turning radius	965 mm (38")
Ground clearance	80 mm



<b>Dimensions and weights (rear-wheel drive; mobility base = size 1)*</b>	
Caster wheel tyre size	9"/10"
Drive wheel tyre size	14"
<b>Dimensions and weights (rear-wheel drive; mobility base = size 2)*</b>	
Overall width (standard motor/performance or high performance motor)**	626 / 642 mm (24.6" / 25.3")
Overall height (equipped with standard seat)	850–1,110 mm (33.4"–43.7")
Overall height (equipped with VAS seat)	850–1,110 mm (33.4"–43.7")
Overall length (without leg support)	870 mm (34.3")
Overall length (with leg support)	Minimum: 1050 mm (41.3"); maximum: 1250 mm (49.2")
Arm support length (standard)	260 mm (10.2")
Foremost point of the side panel (measured to back support)	Minimum: 300 mm (11.8"); maximum: 580 mm (22.8")
Transport weights***	See "Weight", of this, weight of removable components: Leg support (standard): approx. 2.2 kg (4.9 lbs) Detachable side panel: approx. 3 kg (6.6 lbs) Leg support (power, with aluminium foot plate): approx. 6.5 kg (14.3 lbs)
Minimum turning radius	965 mm (38")
Ground clearance	80 mm
Caster wheel tyre size	9"/10"
Drive wheel tyre size	14"

\* Depending on equipment selected

\*\* May be larger due to seat width adjustment. Overall width +180 mm in the assembled state.

\*\*\* Weight of the heaviest component

<b>Dimensions and weights (mid-wheel drive; mobility base = size 1)*</b>	
Overall width (standard motor/performance or high performance motor)**	596 / 612 mm (23.5" / 24.1")
Overall height (equipped with standard seat)	850–1,110 mm (33.4"–43.7")
Overall height (equipped with VAS seat)	850–1,110 mm (33.4"–43.7")
Overall length (without leg support)	908 mm (35.75")
Overall length (with leg support)	Minimum: 1050 mm (41.3"); maximum: 1250 mm (49.2")
Arm support length (standard)	260 mm (10.2")
Foremost point of the side panel (measured to back support)	Minimum: 300 mm (11.8"); maximum: 580 mm (22.8")
Transport weights***	See "Weight", of this, weight of removable components: Leg support (standard): approx. 2.2 kg (4.9 lbs) Detachable side panel: approx. 3 kg (6.6 lbs) Leg support (power, with aluminium foot plate): approx. 6.5 kg (14.3 lbs)
Minimum turning radius	750 mm (29.5")
Ground clearance	80 mm (3")
Tyre size front/rear	6"
Drive wheel tyre size	14"

<b>Dimensions and weights (mid-wheel drive; mobility base = size 2)*</b>	
Overall width (standard motor/performance or high performance motor)**	626 / 642 mm (24.6" / 25.3")
Overall height (equipped with standard seat)	850–1,110 mm (33.4"–43.7")
Overall height (equipped with VAS seat)	850–1,110 mm (33.4"–43.7")

<b>Dimensions and weights (mid-wheel drive; mobility base = size 2)*</b>	
Overall length (without leg support)	968 mm (38.1")
Overall length (with leg support)	Minimum: 1050 mm (41.3"); maximum: 1250 mm (49.2")
Arm support length (standard)	260 mm (10.2")
Front position of the arm supports (measured to the back support)	Minimum: 300 mm (11.8"); maximum: 580 mm (22.8")
Transport weights***	See "Weight", of this, weight of removable components: Leg support (standard): approx. 2.2 kg (4.9 lbs) Detachable side panel: approx. 3 kg (6.6 lbs) Leg support (power, with aluminium foot plate): approx. 6.5 kg (14.3 lbs)
Minimum turning radius	750 mm (29.5")
Ground clearance	80 mm (3")
Tyre size front/rear	6"
Drive wheel tyre size	14"

\* Depending on equipment selected

\*\* May be larger due to seat width adjustment. Overall width +180 mm in the assembled state.

\*\*\* Weight of the heaviest component

<b>Transportation size (storage length x storage width x storage height)</b>	
Storage length	1100 mm (43.3")
Storage width	Minimum: 596 mm (23.5"); maximum: 630 mm (24.8")
Storage height	500 mm (19.7")

<b>Seat and back support adjustment</b>	
Seat inclination*	Minimum: 0°; maximum: 45°
Set pre-tilt of the seat	-3°/0°/3°/6°/9° (depending on order and/or selected option)
Back support angle**	Minimum: 90°; maximum: 120°
Leg support angle***	Minimum: 90°; maximum: 165°

\* Maximum value only with power seat tilt option; specifications do not take set pre-tilt into account

\*\* Specifications do not take set pre-tilt into account

\*\*\* \* Maximum value only with power leg support option + manually adjustable leg supports; specifications do not take set pre-tilt into account

<b>Seat function (power)</b>	
Back support angle adjustment*	Continuously adjustable up to 30°
Seat tilt*	Adjustable up to 45° (with centre of gravity shift)
Seat height adjustment*	Adjustable up to 350 mm (13.8"); max. load: up to 180 kg (397 lbs)
Combined seat height adjustment/seat tilt*	Seat height adjustment: adjustable up to 350 mm (11.8"); seat tilt: adjustable up to 45°; max. load: up to 180 kg (397 lbs)
Leg supports*	Continuously adjustable up to 75°

\* Depending on equipment selected

<b>Seat function (manual)</b>	
Back angle adjustment	Adjustable by up to 30°

<b>Seat function (manual)</b>	
Legrests	Adjustable by up to 75°

<b>Drive wheels</b>	
Wheel size	14"
Tyre type	Pneumatic tyres
Tyre pressure	Adjust the tyre pressure according to the specifications on the tyre sidewall to prevent injuries or damage to the product: 3.5 bar/350 kPa/50 PSI

<b>Drive wheels</b>	
Wheel size	14"
Tyre type	PU tyres
<b>Caster wheels</b>	
Wheel size	10"
Tyre type	Pneumatic tyres
Tyre pressure	Adjust the tyre pressure according to the specifications on the tyre sidewall to prevent injuries or damage to the product: 3.5 bar/350 kPa/50 PSI
<b>Caster wheels</b>	
Wheel size	9"
Tyre type	Pneumatic tyres
Tyre pressure	Adjust the tyre pressure according to the specifications on the tyre sidewall to prevent injuries or damage to the product: 3.5 bar/350 kPa/50 PSI
<b>Caster wheels</b>	
Wheel size	10"
Tyre type	PU tyres
<b>Caster wheels</b>	
Wheel size	9"
Tyre type	PU tyres
<b>Caster wheels</b>	
Wheel size	6"
Tyre type	PU tyres
<b>Driving data (rear-wheel drive/front-wheel drive)</b>	
Speed*	See nameplate for precise information: 6 km/h (3.7 mph); 7.2 km/h (4.4 mph); 10 km/h (6.2 mph); 14 km/h (8.7 mph)
Climbing ability (base model)**	10° (17.5 %)
Dynamic stability – uphill***	10° (17.5 %)
Static stability – uphill/downhill	10° (17.5 %)
Static stability – sideways	10° (17.5 %)
Maximum obstacle height	With front-wheel drive: 75 mm (3") With rear-wheel drive: 50 mm (2"); with curb climbing assist: 100 mm (4")
Braking distance (according to DIN EN 12184)****	At 6 km/h (3.7 mph): 1,000 mm (39.4") – horizontal At 7.2 km/h (4.4 mph): 1,200 mm (47.2") – horizontal At 10 km/h [6.2 mph]: 2,100 mm (82.7") – horizontal At 14 km/h [8.7 mph]: 3,900 mm (153.5") – horizontal
<b>Driving data (front-wheel drive)</b>	
Speed*	See nameplate for precise information: 6 km/h (3.7 mph); 7.2 km/h (4.4 mph); 10 km/h (6.2 mph)
Climbing ability (base model)**	6° (10.5 %)
Dynamic stability – uphill***	6° (10.5 %)
Static stability – uphill/downhill	6° (10.5 %)
Static stability – sideways	6° (10.5 %)
Maximum obstacle height	50 mm (3")
Braking distance (according to DIN EN 12184)****	At 6 km/h (3.7 mph): 1,000 mm (39.4") – horizontal At 7.2 km/h (4.4 mph): 1,200 mm (47.2") – horizontal At 10 km/h [6.2 mph]: 2,100 mm (82.7") – horizontal

\* The specified speed can vary by  $\pm 10\%$ .

\*\* The control device and the motors must be protected against overloading. For this reason, the continuous climbing ability depends on the overall weight (wheelchair weight + user weight + luggage) as well as the ground conditions, exterior temperature, battery voltage and user's driving style. In individual cases, the continuous climbing ability can be significantly lower than the value specified.

\*\*\* Approved climbing ability with lowered seat functions, upright back support and lowered leg supports.

\*\*\*\* The braking distance can be correspondingly longer due to user weight, luggage, installed options and condition of the tyres, and due to weather and surface conditions.

<b>Driving data (mid-wheel drive)</b>	
Speed*	See nameplate for precise information: 6 km/h (3.7 mph); 7.2 km/h (4.4 mph); 10 km/h (6.2 mph)
Climbing ability (base model)**	10° (17.5 %)
Dynamic stability – uphill***	10° (17.5 %)
Static stability – uphill/downhill	10° (17.5 %)
Static stability – sideways	10° (17.5 %)
Maximum obstacle height	65 mm (2.5")
Braking distance (according to DIN EN 12184:2014)****	At 6 km/h (3.7 mph): 1,000 mm (39.4") – horizontal At 7.2 km/h (4.4 mph): 1,200 mm (47.2") – horizontal At 10 km/h [6.2 mph]: 2,100 mm (82.7") – horizontal

<b>Driving data (mid-wheel drive)</b>	
Speed*	See nameplate for precise information: 6 km/h (3.7 mph); 7.2 km/h (4.4 mph); 10 km/h (6.2 mph)
Climbing ability (base model)**	6° (10.5 %)
Dynamic stability – uphill***	6° (10.5 %)
Static stability – uphill/downhill	6° (10.5 %)
Static stability – sideways	6° (10.5 %)
Maximum obstacle height	50 mm (2.5")
Braking distance (according to DIN EN 12184:2014)****	At 6 km/h (3.7 mph): 1,000 mm (39.4") – horizontal At 7.2 km/h (4.4 mph): 1,200 mm (47.2") – horizontal At 10 km/h [6.2 mph]: 2,100 mm (82.7") – horizontal

\* The specified speed can vary by ±10%.

\*\* The control device and the motors must be protected against overloading. For this reason, the continuous climbing ability depends on the overall weight (wheelchair weight + user weight + luggage) as well as the ground conditions, exterior temperature, battery voltage and user's driving style. In individual cases, the continuous climbing ability can be significantly lower than the value specified.

\*\*\* Approved climbing ability with lowered seat functions, upright back support and lowered leg supports.

\*\*\*\* The braking distance can be correspondingly longer due to user weight, luggage, installed options and condition of the tyres, and due to weather and surface conditions.

<b>Range (on level surfaces)*</b>	
Battery with 39 Ah (C5) / 50 Ah (C20)	approx. 25 km (15.5 miles)

\* The specified range was determined under defined conditions according to ISO 7176-4. In practice the range can be reduced by up to **50%**. For information on this, see the section "Range" in the instructions for use (user).

<b>Range (on level surfaces)*</b>	
Battery with 53 Ah (C5) / 62 Ah (C20)	approx. 26 km (16 miles)

\* The specified range was determined under defined conditions according to ISO 7176-4. In practice the range can be reduced by up to **50%**. For information on this, see the section "Range" in the instructions for use (user).

<b>Driving distance range (on level surfaces)*</b>	
Battery with 56 Ah (C5) / 60,4 Ah (C20)	Approx. 35 km (22 miles)

\* The specified driving distance range was determined under defined conditions according to ISO 7176-4. In practice the driving distance range can be reduced by up to **50%**. For information on this, see the section "Driving distance range" in the instructions for use (user).

<b>Range (on level surfaces)*</b>	
Battery with 63 Ah (C5) / 74 Ah (C20)	Approx. 35 km (22 miles)

\* The specified range was determined under defined conditions according to ISO 7176-4. In practice the range can be reduced by up to **50 %**. For information on this, see the section "Range" in the instructions for use (user).

<b>Range (on level surfaces)*</b>	
Battery with 75 Ah (C5) / 80 Ah (C20)	approx. 40 km (24.8 miles)

\* The specified range was determined under defined conditions according to ISO 7176-4. In practice the range can be reduced by up to **50%**. For information on this, see the section "Range" in the instructions for use (user).

<b>Electrical system*</b>	
IP protection rating (according to DIN EN 60529)	IP44
Operating voltage	24 V DC
Lighting	
LED front light	24 V, maintenance-free
LED rear light	24 V, maintenance-free
Automatic circuit breaker	100 A
Battery charger	For more information see the included battery charger instructions for use

\* The product meets all requirements under ISO 7176-14.

<b>Battery</b>	
Batteries	2 x 12 V; 39 Ah (C5) / 50 Ah (C20); gel; maintenance-free

<b>Battery</b>	
Batteries	2 x 12 V; 53 Ah (C5) / 62 Ah (C20); AGM; maintenance-free

<b>Battery</b>	
Batteries	2 x 12 V; 56 Ah (C5) / 60,4 Ah (C20); AGM; maintenance-free

<b>Battery</b>	
Batteries	2 x 12 V; 63 Ah (C5) / 75 Ah (C20); AGM; maintenance-free

<b>Battery</b>	
Batteries	2 x 12 V; 63 Ah (C5) / 74 Ah (C20); gel; maintenance-free

<b>Battery</b>	
Batteries	2 x 12 V; 75 Ah (C5) / 80 Ah (C20); AGM; maintenance-free

<b>Battery (not delivered by Ottobock)</b>	
Required specifications	2 x 12 V; up to max. 75 Ah (C5)/ up to max. 92 Ah (C20); gel or AGM; maintenance-free

<b>Battery charger (not supplied by Ottobock)*</b>	
Required minimum specifications**	<p>Battery chargers for a rated battery capacity of 25–55 Ah: 8 A                      Battery chargers for a rated battery capacity of 45–65 Ah: 10 A                      Battery chargers for a rated battery capacity of 55–75 Ah: 12 A***</p> <p>Protective insulation (class 2) according to IEC 60335-2-29; protection rating: IP21 (Ottobock recommends battery chargers with a protection rating of IP21)</p> <p>The battery charger fulfils the normative requirements of EN 12184. This also includes the requirements according to ISO 7176-14 (battery charger with reverse polarity protection; battery charger charges batteries to at least 80 per cent within 8 hours; battery charger includes information regarding nominal capacity and the possibility of charging overnight; battery charger indicates that the battery is properly connected)</p> <p>The device fulfils the normative requirements of ISO 7176-21 and ISO 7176-25.</p>

\* For further details, see the instructions for use supplied with the battery charger.

\*\* Note the deviating information of individual battery manufacturers.

\*\*\* 12 A only when charging via a separate charging receptacle.

<b>Control device</b>	
Model	VR2*
Max. output current per motor	90 A
Force for operating the joystick on the standard control panel	1.6 N

\* Without power seat functions, without lights

<b>Control device</b>	
Model	VR2
Max. output current per motor	90 A
Seat functions that can be controlled	Maximum 2
Force for operating the joystick on the standard control panel	1.6 N

<b>Control device</b>	
Model	R-Net (controller in combination with TEN° control panel)
Max. output current per motor	90 A
Seat functions that can be controlled	1 (for direct control without actuator module)
Force for operating the joystick on the standard control panel	1.6 N

<b>Control device</b>	
Model	R-Net (controller in combination with TEN° control panel)
Max. output current per motor	120 A (seat functions are controlled via the separate actuator module)
Force for operating the joystick on the standard control panel	1.6 N

<b>Control device</b>	
Model	R-Net (controller in combination with JSM-LED-L control panel)
Max. output current per motor	120 A
Seat functions that can be controlled	1 (for direct control without actuator module)
Force for operating the joystick on the standard control panel	1.6 N

<b>Control device accessories</b>	
Model	TEN° LCD module
Nominal input voltage	24 V
Operating voltage range	16–33 V
Absolute maximum voltage	35 V
Weight	Display module: 120 g Connection module: 200 g
Case material	Plastic
Protection rating	IPX4
IR frequency range	10–455 kHz
Sip and puff control port	Full puff pressure: approx. 69 mbar Full sip pressure: approx. -83 mbar

<b>Control device accessories</b>	
Model	R-Net actuator module for controlling up to 6 seat functions
Max. output current per motor	15 A

<b>Allowable environmental conditions</b>	
Operating temperature	-15 °C to +40 °C (+5 °F to +104 °F)
Transport and storage temperature	-15 °C to +40 °C (+5 °F to +104 °F)
Relative humidity	45% to 85%; non-condensing

Corrosion protection	
Corrosion protection	Cathodic dip coating / powder coating

## 12 Appendices

### 12.1 Threshold values for wheelchairs transportable by train

<b>INFORMATION</b>
<ul style="list-style-type: none"> <li>▶ The products in this series fully satisfy the minimum technical requirements of regulation (EU) No. 1300/2014 regarding train accessibility for people with disabilities. However, not all versions can comply with all threshold values due to different settings.</li> <li>▶ With the help of the table that follows, you or the qualified personnel can take measurements and verify whether the specific product in question meets the threshold values.</li> </ul>

Feature	Threshold value (according to regulation (EU) No. 1300/2014)
Length	1200 mm (47.2"); plus 50 mm (2") for the feet
Width	700 mm (27.6"); plus 50 mm (2") on each side for the hands when moving
Smallest wheels	approx. 3" or greater according to the regulation, the smallest wheel must be able to accommodate a gap measuring 75 mm (3") horizontally and 50 mm (2") vertically
Height	max. 1375 mm (54.1"); including a 1.84 m (72.5") large male wheelchair user (95th percentile)
Turning radius	1500 mm (59.1")
Maximum weight	300 kg (661 lbs); for wheelchair with occupant, including baggage
Maximum obstacle height that can be overcome	50 mm (2")
Ground clearance	60 mm (2.4"); at an upward slope angle of 10°, ground clearance must measure at least 60 mm (2.4") under the foot rest for going forward at the end of the slope
Maximum inclination angle on which the wheelchair will remain stable	6° (dynamic stability in all directions) 9° (static stability in all directions, also when wheel lock engaged)

### 12.2 Sound emission information

<b>INFORMATION</b>
<ul style="list-style-type: none"> <li>▶ The products in the series were tested for compliance with maximum sound emission requirements according to the ISO 7176-14 standard.</li> <li>▶ They fully meet the requirements according to the areas of application identified below.</li> </ul>

Area of application	Maximum sound pressure level <sup>1)</sup>
In enclosed rooms	65 db(A)
Outside of enclosed rooms	75 db(A)

<sup>1)</sup> Depending on the area of application according to ISO 7176-14



A series of horizontal lines spanning the width of the page, providing a template for writing.







# Kundenservice/Customer Service

## Europe

Otto Bock HealthCare Deutschland GmbH  
Max-Näder-Str. 15 · 37115 Duderstadt · Germany  
T +49 5527 848-3433 · F +49 5527 848-1460  
healthcare@ottobock.de · www.ottobock.de

Otto Bock Healthcare Products GmbH  
Brehmstraße 16 · 1110 Wien · Austria  
F +43 1 5267985  
service-admin.vienna@ottobock.com · www.ottobock.at

Otto Bock Adria d.o.o. Sarajevo  
Ramiza Salčina 85  
71000 Sarajevo · Bosnia-Herzegovina  
T +387 33 255-405 · F +387 33 255-401  
obadria@bih.net.ba · www.ottobockadria.com.ba

Otto Bock Bulgaria Ltd.  
41 Tzar Boris III' Blvd. · 1612 Sofia · Bulgaria  
T +359 2 80 57 980 · F +359 2 80 57 982  
info@ottobock.bg · www.ottobock.bg

Otto Bock Suisse AG  
Luzerner Kantonsspital 10 · 6000 Luzern 16 · Suisse  
T +41 41 455 61 71 · F +41 41 455 61 70  
suisse@ottobock.com · www.ottobock.ch

Otto Bock ČR s.r.o.  
Protetická 460 · 33008 Zruč-Senec · Czech Republic  
T +420 377825044 · F +420 377825036  
email@ottobock.cz · www.ottobock.cz

Otto Bock Iberica S.A.  
C/Majada, 1 · 28760 Tres Cantos (Madrid) · Spain  
T +34 91 8063000 · F +34 91 8060415  
info@ottobock.es · www.ottobock.es

Otto Bock France SNC  
4 rue de la Réunion · CS 90011  
91978 Courtaboeuf Cedex · France  
T +33 1 69188830 · F +33 1 69071802  
information@ottobock.fr · www.ottobock.fr

Otto Bock Healthcare plc  
32, Parsonage Road · Englefield Green  
Egham, Surrey TW20 0LD · United Kingdom  
T +44 1784 744900 · F +44 1784 744901  
bockuk@ottobock.com · www.ottobock.co.uk

Otto Bock Hungária Kft.  
Tatai út 74. · 1135 Budapest · Hungary  
T +36 1 4511020 · F +36 1 4511021  
info@ottobock.hu · www.ottobock.hu

Otto Bock Adria d.o.o.  
Dr. Franje Tuđmana 14 · 10431 Sveta Nedelja · Croatia  
T +385 1 3361 544 · F +385 1 3365 986  
ottobockadria@ottobock.hr · www.ottobock.hr

Otto Bock Italia Srl Us  
Via Filippo Turati 5/7 · 40054 Budrio (BO) · Italy  
T +39 051 692-4711 · F +39 051 692-4720  
info.italia@ottobock.com · www.ottobock.it

Otto Bock Benelux B.V.  
Mandenmaker 14 · 5253 RC  
Nieuwkuijk · The Netherlands  
T +31 73 5186488 · F +31 73 5114960  
info.benelux@ottobock.com · www.ottobock.nl

Industria Ortopédica Otto Bock Unip. Lda.  
Av. Miguel Bombarda, 21 - 2º Esq.  
1050-161 Lisboa · Portugal  
T +351 21 3535587 · F +351 21 3535590  
ottobockportugal@mail.telepac.pt

Otto Bock Polska Sp. z o. o.  
Ulica Korolowa 3 · 61-029 Poznań · Poland  
T +48 61 6538250 · F +48 61 6538031  
ottobock@ottobock.pl · www.ottobock.pl

Otto Bock Romania srl  
Șos de Centura Chitila - Mogoșoaia Nr. 3  
077405 Chitila, Jud. Ilfov · Romania  
T +40 21 4363110 · F +40 21 4363023  
info@ottobock.ro · www.ottobock.ro

OOO Otto Bock Service  
p/o Pultikovo, Business Park „Greenwood”,  
Building 7, 69 km MKAD  
143441 Moscow Region/Krasnogorskiy Rayon  
Russian Federation  
T +7 495 564 8360 · F +7 495 564 8363  
info@ottobock.ru · www.ottobock.ru

Otto Bock Scandinavia AB  
Postal: Box 4041 · 169 04 Solna · Sweden  
Visiting: Barks Väg 7, Solna, Sweden  
SE: T +46 11 28 06 89 · NO: T +47 23142600  
FI: T +35 8 10 400 6940 · DK: T +45 70 22 32 74  
To order: order@ottobock.se  
Inquiries: info@ottobock.se  
professionals.ottobock.se

Otto Bock Slovakia s.r.o.  
Röntgenova 26 · 851 01 Bratislava 5 · Slovak Republic  
T +421 2 32 78 20 70 · F +421 2 32 78 20 89  
info@ottobock.sk · www.ottobock.sk

Otto Bock Sava d.o.o.  
Industrijska bb · 34000 Kragujevac · Republika Srbija  
T +381 34 351 671 · F +381 34 351 671  
info@ottobock.rs · www.ottobock.rs

Otto Bock Ortopedi ve  
Rehabilitasyon Tekniği Ltd. Şti.  
Mecidiyeköy Mah. Latı Lokum Sok.  
Meriç Sitesi B Blok No: 30/B  
34387 Mecidiyeköy-İstanbul · Turkey  
T +90 212 3565040 · F +90 212 3566688  
info@ottobock.com.tr · www.ottobock.com.tr

## Africa

Otto Bock Algérie E.U.R.L.  
32, rue Ahcène Outaleb · Coopérative les Mimosas  
Mackle-Ben Aknoun · Alger · DZ Algérie  
T +213 21 913863 · F +213 21 913863  
information@ottobock.fr · www.ottobock.fr

Otto Bock Egypt S.A.E.  
28 Soliman Abaza St. Mohandessein · Giza · Egypt  
T +20 2 37606818 · F +20 2 37605734  
info@ottobock.com.eg · www.ottobock.com.eg

Otto Bock South Africa (Pty) Ltd  
Building 3 Thornhill Office Park · 94 Bekker Road  
Midrand · Johannesburg · South Africa  
T +27 11 564 9360  
info-southafrica@ottobock.co.za  
www.ottobock.co.za

## Americas

Otto Bock Argentina S.A.  
Av. Belgrano 1477 · CP 1093  
Ciudad Autónoma de Buenos Aires · Argentina  
T +54 11 5032-8201 / 5032-8202  
atencionclientes@ottobock.com.ar  
www.ottobock.com.ar

Otto Bock do Brasil Tecnica Ortopédica Ltda.  
Alameda Maria Tereza, 4036, Bairro Dois Córregos  
CEP: 13.278-181, Valinhos-São Paulo · Brasil  
T +55 19 3729 3500 · F +55 19 3269 6061  
ottobock@ottobock.com.br · www.ottobock.com.br

Otto Bock HealthCare Canada  
5470 Harvester Road  
Burlington, Ontario, L7L 5N5, Canada  
T +1 800 665 3327 · F +1 800 463 3659  
CACustomerService@ottobock.com  
www.ottobock.ca

Oficina Ottobock Habana  
Calle 3ra entre 78 y 80.  
Edificio Jerusalem · Oficina 112 · Calle 3ra.  
Playa, La Habana. Cuba  
T +53 720 430 69 · +53 720 430 81  
hector.corcho@ottobock.com.br  
www.ottobock.com.br

Otto Bock HealthCare Andina Ltda.  
Calle 138 No 53-38 · Bogotá · Colombia  
T +57 1 8619988 · F +57 1 8619977  
info@ottobock.com.co · www.ottobock.com.co

Otto Bock de Mexico S.A. de C.V.  
Prolongación Calle 18 No. 178-A  
Col. San Pedro de los Pinos  
C.P. 01180 México, D.F. · Mexico  
T +52 55 5575 0290 · F +52 55 5575 0234  
info@ottobock.com.mx · www.ottobock.com.mx

Otto Bock HealthCare LP  
11501 Alterra Parkway Suite 600  
Austin, TX 78758 · USA  
T +1 800 328 4058 · F +1 800 962 2549  
USCustomerService@ottobock.com  
www.ottobockus.com

## Asia/Pacific

Otto Bock Australia Pty. Ltd.  
Suite 1.01, Century Corporate Centre  
62 Norwest Boulevard  
Baulkham Hills NSW 2153 · Australia  
T +61 2 8818 2800 · F +61 2 8814 4500  
healthcare@ottobock.com.au · www.ottobock.com.au

Beijing Otto Bock Orthopaedic Industries Co., Ltd.  
B12E, Universal Business Park  
10 Jiuxianqiao Road, Chao Yang District  
Beijing, 100015, P.R. China  
T +8610 8598 6880 · F +8610 8598 0040  
news-service@ottobock.com.cn  
www.ottobock.com.cn

Otto Bock Asia Pacific Ltd.  
Unit 1004, 10/F, Greenfield Tower, Concordia Plaza  
1 Science Museum Road, Tsim Sha Tsui  
Kowloon, Hong Kong · China  
T +852 2598 9772 · F +852 2598 7886  
info@ottobock.com.hk · www.ottobock.com

Otto Bock HealthCare India Pvt. Ltd.  
20th Floor, Express Towers  
Nariman Point, Mumbai 400 021 · India  
T +91 22 2274 5500 / 5501 / 5502  
information@indiaottobock.com · www.ottobock.in

Otto Bock Japan K. K.  
Yokogawa Building 8F, 4-4-44 Shibaura  
Minato-ku, Tokyo, 108-0023 · Japan  
T +81 3 3798-2111 · F +81 3 3798-2112  
ottobock@ottobock.co.jp · www.ottobock.co.jp

Otto Bock Korea HealthCare Inc.  
4F Agaworld Building · 1357-74, Seocho-dong  
Seocho-ku, 137-070 Seoul · Korea  
T +82 2 577-3831 · F +82 2 577-3828  
info@ottobockkorea.com · www.ottobockkorea.com

Otto Bock  
South East Asia Co., Ltd.  
Bangkok 10900 · Thailand  
T +66 2 930 3030  
F +66 2 930 3311  
obsea@ottobock.co.th

## Other countries

Ottobock SE & Co. KGaA  
Max-Näder-Straße 15 · 37115 Duderstadt · Germany  
T +49 5527 848-1590 · F +49 5527 848-1676  
reha-export@ottobock.de · www.ottobock.com

Ihr Fachhändler | Your specialist dealer



**Fabricante Legal:**

Otto Bock Mobility Solutions GmbH  
Lindenstraße 13 · 07426 Königsee/Germany  
[www.ottobock.com](http://www.ottobock.com)

**Fabricado por:**

Ottobock Ind. E Com. Imp. E Export. De Cadeiras de Rodas Ltda  
Alfredo Achcar, 970. Bairro Nova Vinhedo  
13280-000 – Vinhedo/SP – Brasil  
CNPJ: 20.445.801/0001-78

**Detentor do Cadastro ANVISA e Distribuidor:**

Ottobock do Brasil Técnica Ortopédica Ltda.  
Alameda Maria Tereza, 4036 · Bairro Dois Córregos  
13278-181 · Valinhos/SP · Brasil  
Fone: (19) 3729-3500 · Fax.: (19) 3729-3539  
CNPJ: 42.463.513/0001-89

