



Avantgarde XXL 2

EN Instructions for use (user) 3

Table of contents

EN

1	Foreword	5
2	Product description	6
2.1	Function	6
2.2	Product overview	6
3	Intended use	7
3.1	Indications for use	7
3.2	Indications	7
3.3	Contraindications	7
3.3.1	Absolute Contraindications	7
3.3.2	Relative Contraindications	7
4	Safety	7
4.1	Explanation of warning symbols	7
4.2	Safety instructions for use	7
4.3	Side effects	10
4.4	Further information	10
4.5	Nameplate	11
5	Delivery	11
5.1	Scope of delivery	11
5.2	Options	11
5.3	Storage	11
5.3.1	Storage during daily use	11
5.3.2	Storage during extended disuse	11
6	Preparing the product for use	12
6.1	Assembly	12
7	Use	13
7.1	Further instructions for use	13
7.2	Getting in and transferring	13
7.3	Legrests	13
7.3.1	Folding the leg supports up and down	14
7.3.2	Removing and attaching the leg supports	15
7.3.3	Removing and fastening the calf strap	15
7.3.4	Adjusting the leg support	16
7.4	Seat and back upholstery	16
7.4.1	Removing and fastening the seat cushion	16
7.5	Backrest	17
7.6	Side panels	17
7.6.1	Adjusting the height of the forearm support	18
7.6.2	Removing the side panels	18
7.6.3	Adjusting an arm support with swivel unit	18
7.7	Push handles	19
7.7.1	Adjusting the height of the push handles	19
7.7.2	Removing the push handles	20
7.8	Stabiliser bar	20
7.9	Drive wheels	21
7.9.1	Removing and mounting the drive wheels	21
7.9.2	Spoke protector	22
7.10	Caster wheels and caster forks	22
7.10.1	Approach in case of stiffness	23
7.11	Wheel locks	23
7.11.1	Using the wheel locks	24
7.11.2	Drum brake	24
7.11.3	Knee lever wheel lock for user and attendant	24
7.11.4	Knee lever wheel lock for one-handed operation (double handrims)	25

7.12	Frame accessories	25
7.12.1	Anti-tipper	25
7.12.1.1	Activating and deactivating the anti-tipper	26
7.12.2	Tip-assist	27
7.12.2.1	Using the tip-assist	27
7.13	Front frame	27
7.14	Lap belt (seat belt)	27
7.15	Transport wheels	28
7.15.1	Using the transport wheels	28
7.16	Crutch holder with hook-and-loop fastening strap	29
7.17	Head and neckrest	29
7.18	Tray	29
7.19	Additional options	30
7.20	Disassembly and transport	30
7.21	Use in vehicles for transporting persons with reduced mobility	31
7.22	Care	31
7.22.1	Cleaning	31
7.22.1.1	Cleaning by hand	31
7.22.1.2	Cleaning the seat cushion	31
7.22.1.3	Cleaning belts/straps	32
7.22.2	Disinfection	32
8	Maintenance and repair	33
8.1	Maintenance	33
8.1.1	Maintenance intervals	33
8.1.2	Maintenance tasks	33
8.2	Repair	34
8.2.1	Inner tube, rim tape and tyre replacement	34
9	Disposal	35
9.1	Disposal information	35
10	Legal information	35
10.1	Liability	35
10.2	Warranty	35
10.3	Service life	35
11	Technical data	36
12	Appendices	37
12.1	Threshold values for wheelchairs transportable by train	37

1 Foreword

INFORMATION

Date of last update: 2020-04-20

- ▶ Please read this document carefully before using the product and observe the safety notices.
- ▶ Obtain instruction from the qualified personnel in the safe use of the product.
- ▶ Please contact the qualified personnel if you have questions about the product or in case of problems.
- ▶ Report each serious incident in connection with the product, in particular a worsening of the state of health, to the manufacturer and to the relevant authority in your country.
- ▶ Please keep this document for your records.

INFORMATION

- ▶ New information regarding product safety and product recalls as well as the declaration of conformity can be obtained at oa@ottobock.com or from the manufacturer's service department (see inside or outside of back cover for addresses).
- ▶ You can request this document as a PDF file at oa@ottobock.com or from the manufacturer's service department (see inside or outside of back cover for addresses). The PDF file can also be displayed in a larger size.

You have received a product that is very versatile for everyday use at home and outdoors.

In order to exclude injuries of any type, familiarise yourself with the handling, functions and intended use of the product before using it. These instructions for use provide you with the related necessary information.

Please note the following in particular:

- All users and/or their attendants must be trained by qualified personnel in the use of the product. In particular, users and/or attendants must be informed of the residual risks with the aid of the safety notices in the instructions for use (user).
- The product was adapted to the needs of the user. Subsequent changes may be made only by qualified personnel. We recommend checking the product settings **once per year** to ensure optimal treatment over the long term. Especially for users with a changing anatomy (for example body dimensions, weight), an adjustment at least **once every six months** is recommended.
- Your product may differ from the models shown. In particular, not all the options described in these instructions for use will be installed on your product.
- The manufacturer reserves the right to make technical changes to the model described in these instructions for use.

2 Product description

2.1 Function

The wheelchair is intended exclusively for transporting one person on the seat.
The wheelchair can be used on solid ground both indoors and outdoors.

2.2 Product overview



Maximum load: 180 kg

1	Push handle (here with stabiliser bar)	7	Frame with crossbrace
2	Back support, back support upholstery	8	Leg support
3	Side panel	9	Caster wheel
4	Seat with seat cushion	10	Caster fork
5	Seat pad	11	Drive wheel with handrim
6	Wheel lock	12	Release button for quick-release axle

3 Intended use

The safe use of the product can only be ensured in case of intended use in accordance with the information contained in these instructions for use. The user is ultimately responsible for accident-free operation.

3.1 Indications for use

The wheelchair is intended for everyday indoor and outdoor use, by the user or an attendant, of people with temporary or permanent limitations of the ability to walk, inability to walk or difficulty standing up.

The product is suitable for users with intact skin whose anatomy (such as body dimensions and weight) permits the intended use of the product.

The wheelchair may only be used with the options listed on the product order form.

Ottobock assumes no liability for combinations with medical devices and/or accessories from other manufacturers outside the modular system.

Combinations based on a combination agreement that have been evaluated for effectiveness and safety are an exception to this.

3.2 Indications

- Minor to pronounced or complete restrictions of mobility

3.3 Contraindications

3.3.1 Absolute Contraindications



- None known

3.3.2 Relative Contraindications

- Failure to meet physical or mental requirements

4 Safety

4.1 Explanation of warning symbols

 WARNING	Warning regarding possible serious risks of accident or injury.
 CAUTION	Warning regarding possible risks of accident or injury.
 NOTICE	Warning regarding possible technical damage.

4.2 Safety instructions for use

Hazards during preparation for use

 WARNING
Independent modification of settings
Serious injuries to the user due to improper changes to the product
<ul style="list-style-type: none"> ▶ Do not modify the settings established by the qualified personnel. Only the settings described in the section "Use" in these instructions for use may be adjusted independently. ▶ In case of problems with the settings, please contact the qualified personnel who adjusted your product.

 WARNING
Settings outside the safety limits
Tipping over, falling due to adjustment errors because of failure to observe the physical/psychological requirements of the user
<ul style="list-style-type: none"> ▶ In certain versions and with certain settings, the product tends to tip backwards due to its design. This is an intentional feature designed to enable users with the corresponding physical prerequisites to manoeuvre quickly and nimbly. ▶ Users with the necessary physical and psychological preconditions can be supplied with such versions/settings. If the physical/psychological preconditions change, the product may no longer be used with these settings. Inform the responsible qualified personnel immediately in this case.

⚠ WARNING

Improper handling of packaging materials

Risk of suffocation due to neglect of the duty to supervise

- ▶ Packaging materials must be kept out of the reach of children.

Risk of hand injuries

⚠ CAUTION

Pinching on components

Pinching, crushing due to lack of caution in danger areas

- ▶ Do not reach between the drive wheel and wheel lock or drive wheel and side panel when driving the wheelchair.
- ▶ Do not reach into the spokes of the rotating drive wheel.
- ▶ Pay attention not to pinch parts of your body at the wheel lock lever or between the side or frame parts.

⚠ CAUTION

Heat development when braking with handrims

Burns due to insufficient hand protection

- ▶ Wear wheelchair gloves when travelling at high speeds.

Hazards while driving

⚠ WARNING

Improper use of the wheel lock

Falling due to abrupt braking, rolling away of the wheelchair, damage to the wheel lock

- ▶ Do not use the wheel lock as a driving brake.
- ▶ Apply the wheel lock to prevent the wheelchair from moving on uneven ground or during transfers (e.g. into a car).

⚠ CAUTION

Lack of driving experience

Tipping over, falling due to errors in handling the product

- ▶ Practise on level, open ground first.
- ▶ Learn with the support of an assistant how the product reacts to changes in centre of gravity, e.g. downward or upward slopes, inclines or when overcoming obstacles.

⚠ CAUTION

Leaning forward in the wheelchair

Tipping over, overturning due to incorrect centre of gravity

- ▶ Do not lean too far out of the wheelchair when trying to pick up objects.
- ▶ Lean well forward with your upper body when climbing gradients, overcoming obstacles on gradients or on ramps. If users cannot lean their upper body forward, accompanying persons must support the wheelchair from behind.

⚠ CAUTION

Risky operation

Falling, tipping over backwards due to approaching obstacles incorrectly

- ▶ Push slowly when crossing obstacles (e.g. steps, curbs) and negotiating uphill or downhill slopes and inclines.
- ▶ Never cross obstacles at an angle. Always approach obstacles head on (at an angle of 90°).
- ▶ Raise the front wheels before crossing obstacles.
- ▶ Avoid collisions with obstacles and dropping off curbs/ledges.
- ▶ Avoid riding cross-country.

⚠ CAUTION**Lack of tipping resistance on public transport**

Tipping over, user falls, damage to the product due to incorrect positioning

- ▶ When using public transit, always observe the currently applicable legal requirements and the safety notices of the public transit operator.
- ▶ Use the permanently installed seats in the vehicle. If you depend on using your wheelchair as a seat, please use the designated wheelchair spaces and safety securing equipment provided. Always ensure that you are held in place securely.

⚠ CAUTION**Incorrect handling at level crossings**

User may fall or tip over due to driving error

- ▶ Only cross railway systems and railway tracks in the designated areas.
- ▶ Negotiate level crossings so the caster wheels of the product cannot get caught in the gap between the rail and the road surface.

⚠ CAUTION**Driving in the dark**

Risk of collisions with other traffic participants due to lack of lighting

- ▶ Wear bright clothing or clothing with reflectors.
- ▶ Install active lighting on your product.
- ▶ Ensure that the reflectors on the product are clearly visible.

Hazards when overcoming obstacles**⚠ WARNING****Overcoming steps and obstacles without assistance**

Tipping over, falling of the user due to failure to observe transportation instructions

- ▶ Always have accompanying persons help you negotiate steps and other obstacles.
- ▶ Use available facilities (e.g. access ramps or lifts).
- ▶ If such facilities are not available, have 2 assistants carry you over the obstacle.

⚠ WARNING**Improper lifting by attendants**

Tipping over, falling of the user due to lifting on components that come loose or are not intended for lifting

- ▶ Only lift the product on permanently welded components (e.g. main frame).
- ▶ Do not lift the product on components installed with screw connections or add-on components.

Hazard in case of broken skin**⚠ CAUTION****Skin damage**

Skin damage or pressure points due to overloading

- ▶ Check your skin for intactness before and during use of the product.
- ▶ Pay attention to diligent skin care and pressure redistribution during interruptions in using the product.
- ▶ If skin damage or other problems occur during use, stop using the product. Consult the qualified personnel.

Hazards due to fire, heat and cold**⚠ CAUTION****Extreme temperatures**

Hypothermia or burns due to contact with components, failure of components

- ▶ Do not expose the product to any extreme temperatures (e.g. direct sunlight, sauna, extreme cold).
- ▶ Do not leave the product in the immediate vicinity of heaters.

Hazards due to improper use of the product

⚠ WARNING

Overloading

Severe injuries if the product tips over due to overloading, damage to the product

- ▶ Do not exceed the maximum load capacity (see the nameplate and section "Technical data").
- ▶ Please note that certain accessories and add-on components will reduce the remaining load capacity.

⚠ WARNING

Exceeding the service life

Serious injuries due to failure to observe the manufacturer's requirements

- ▶ Using the product beyond the specified expected service life leads to increased residual risk.
- ▶ Observe the specified service life.

⚠ WARNING

Incorrect pushing or pulling of the wheelchair

Risk of falling, tipping over due to user error

- ▶ Only the push handles may be used for pushing or overcoming obstacles. The tip-assist should be used in addition.
- ▶ If a stabiliser bar is installed, it must **not** be used for pulling or pushing.
- ▶ The attendant should make sure that he/she has a secure stance and firm grip (on both sides).
- ▶ In case of damage, have the push handles repaired promptly.

⚠ CAUTION

Use of the product during diagnostic examinations and therapeutic treatment

Impairment of the examination results or the effectiveness of treatment due to interactions of the product with devices that are used

- ▶ Make sure that examinations and treatments are carried out exclusively under the prescribed conditions.

⚠ CAUTION

Uncontrolled driving behaviour, unexpected sounds or odours

Falling, tipping, collision with persons or nearby objects due to defects

- ▶ If any faults, defects or other hazards that can lead to personal injury are detected, the product must be taken out of service immediately. This includes uncontrolled movements as well as sounds that are unexpected or previously not noted or odours that deviate significantly from the state of the product at the time of delivery.
- ▶ Contact the qualified personnel.

NOTICE

Use under incorrect environmental conditions

Damage to product due to corrosion or abrasion

- ▶ Do not use the product in salt water.
- ▶ Make sure that the wheel bearings are not damaged by sand or other particles.

4.3 Side effects

The following side effects may occur during use of the product:

- Neck, muscle and joint pain
- Circulatory disorders, risk of pressure sores

Contact a doctor or therapist in case of problems.

4.4 Further information

INFORMATION

Even in the event of compliance with all applicable guidelines and standards, alarm systems (e.g. in department stores) may respond to your product. Should this happen, remove your product from the area where the alarm was triggered.

INFORMATION

The serial number required for enquiries and orders can be found on the nameplate. For explanations of the nameplate, see the section "Nameplate" (see Page 11).

4.5 Nameplate

The nameplates are found on the frame.

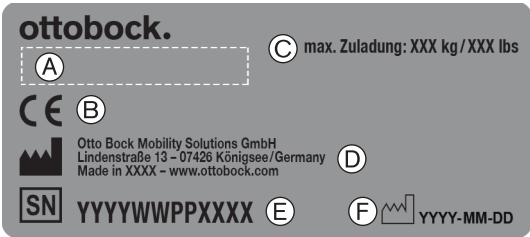
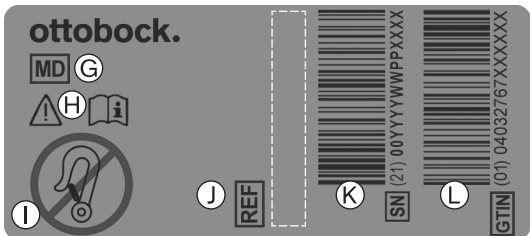
Label	Meaning
	A Manufacturer's product name
	B CE marking
	C Maximum load (see section "Technical data")
	D Manufacturer information/address
	E Serial number ¹⁾
	F Manufacturing date ²⁾
	G Symbol for medical device
	H WARNING! Read the instructions for use before using the product. Observe important safety-related information (e.g. warnings, precautions).
	I The product has not been approved by the manufacturer for use as a seat in vehicles for transporting persons with reduced mobility
	J Manufacturer's reference number for the product variant
	K Serial number (PI) ^{3),1)}
	L Global Trade Item Number (DI) ⁴⁾

¹⁾ YYYY = year of manufacture; WW = week of manufacture; PP = production site; XXXX = sequential production number

²⁾ YYYY = year of manufacture; MM = month of manufacture; DD = day of manufacture

³⁾ UDI-PI to GS1 standard; UDI = Unique Device Identifier, PI = Product Identifier

⁴⁾ UDI-DI to GS1 standard; UDI = Unique Device Identifier, DI = Device Identifier

5 Delivery**5.1 Scope of delivery**

- Wheelchair ready for use
- Instructions for use (user)
- Instructions for use for accessories (depending on equipment)

5.2 Options

The standard model can be fitted to the user's personal requirements thanks to a large range of options. For use of these options: see Page 13 ff.

5.3 Storage**5.3.1 Storage during daily use**

The product should always be stored so it is protected against external influences.

5.3.2 Storage during extended disuse

The product must be stored in a dry place. Specific information for extended storage: see Page 36.

It is not necessary to disassemble the product.

Maintain sufficient clearance from sources of heat. If the product is parked for an extended period of time or the tyres overheat (e.g. in the vicinity of radiators or in case of exposure to strong sunlight behind glass), the tyres may become permanently deformed.

During extended storage, the knee lever wheel lock on wheelchairs with PU tyres (= tubeless tyres) must be released since tyre deformation may otherwise result.

6 Preparing the product for use

6.1 Assembly

⚠ CAUTION

Exposed pinch points

Crushing, pinching due to incorrect handling

- ▶ When folding the wheelchair out or together, only grip by the specified components.

⚠ CAUTION

Failure to verify readiness for use before putting into operation

Tipping, falling due to incorrect adjustment or installation

- ▶ Before you start using the wheelchair for the first time, check the chosen wheelchair settings with the support of qualified personnel.
- ▶ After every assembly, check for proper mounting of the drive wheels. The quick-release axles must be securely locked in the receiver bushings.
- ▶ Pay particular attention to the stability against tipping, free running of the drive wheels and correct function of the wheel locks.
- ▶ Check the tyre pressure. The correct tyre pressure is printed on the sidewall. Ensure that the pressure is the same in both tyres.

INFORMATION

On the topic of disassembly/transport: see Page 30.

It only takes a few simple steps to prepare the wheelchair for use:

- 1) Attach the drive wheels to the quick-release axle mountings (see fig. 2):
 - Press in the button on the quick-release axle.
 - Attach the drive wheel to the quick-release axle mounting and release the button on the quick-release axle.
 - The quick-release axles must not be removable after releasing the push-button.
- 2) Unfold the wheelchair:
 - Loosen the safety strap (see fig. 3).
 - Push the wheelchair apart with your flat hands (see fig. 4).

INFORMATION: While you are next to the wheelchair, tip it slightly toward you and press on the edge of the seat upholstery closest to you.
- 3) **If necessary:** Attach the leg supports (see Page 15).
Fold down the foot plates. With a single-panel foot plate, make sure the support of the foot plate is locked into the receiver (see fig. 5; see Page 14).
- 4) **If necessary:** Fit the seat cushion (see Page 16).





7 Use

7.1 Further instructions for use

- Attaching loads (e.g. backpacks) can adversely affect stability. Therefore, suspending additional loads on the wheelchair is not permitted.
- The recommended overall width for manual wheelchairs in an operational state is **700 mm**. This specification should ensure unhindered use of escape routes, for example. Please note that the product dimensions can exceed the recommended value in versions with very large seat widths (for more information see see Page 36 ff.).
- The wheelchairs in this series fully satisfy the minimum technical requirements for wheelchairs transportable by train. However, please note that it is possible that not every individual wheelchair will fulfil the minimum requirements due to the variation in designs (please see see Page 37 for further details).

7.2 Getting in and transferring

⚠ CAUTION

Incorrect handling when getting in

Risk of falling, tipping or rolling away due to incorrect handling

- ▶ Activate the wheel lock each time before you get into or out of or transfer to or from the wheelchair.
- ▶ Always get into the wheelchair from the side, where possible.
- ▶ Never step on the foot plates when getting in and out.
- ▶ Do not support yourself on the wheel lock when getting in/out.

Users can choose the method for getting into and out of the wheelchair which is most suitable for them. The respective procedure should be discussed and practised with a therapist.

As a rule, the frame tubes, seat bottom or side panels can be used as supports for getting into the wheelchair.

If getting in independently is not possible, transferring or getting in always has to be performed with the help of an assistant. The manufacturer also offers transfer aids for getting in, such as transfer boards.

7.3 Legrests

⚠ CAUTION

Improper use of the legrests

Tipping over, falling due to errors in handling the product

- ▶ Fold up the footplates before getting in.

The leg supports support the user's feet.

The height of the leg support has been adjusted by qualified personnel to the length of the user's lower legs.

The angle of the foot support has been set by the qualified personnel so that it allows the ankles to rest in a comfortable position.

Different leg support types and other accessories may be installed depending on the order:

Single-panel, angle-adjustable leg support (see fig. 6)

The depth of the foot supports is either **125 mm** or **160 mm**.

Segmented, angle-adjustable leg support (see fig. 7)

The foot plates are joined in the centre by a fastening mechanism. The depth of the foot supports is **160 mm**.

**Locking mechanism for single-panel foot plate** (see fig. 10)

The locking mechanism prevents inadvertent loosening of the foot plate, especially for users with spasticity.

Lateral heel blocks for the foot plate (see fig. 8)

Lateral heel blocks prevent the feet from slipping off the leg supports. They can be combined with all segmented and single-panel foot plates with a depth of **160 mm**.

Adjustable lateral heel blocks for the foot plate (see fig. 9)

Lateral heel blocks prevent the feet from slipping off the leg supports. With this version, the position can be additionally adjusted by qualified personnel.

Heel strap (example: see fig. 11, item 2)

The heel strap offers additional support for the user's feet. This prevents the feet from sliding off the foot plate into the danger area.

**7.3.1 Folding the leg supports up and down**

- 1) Hold on to the edge of the foot plate and fold it up (not illustrated).
- 2) Fold the foot plate down:
 - **Only for leg supports with a locking mechanism for single-panel foot plates:** Pull out the locking mechanism and swing the foot plate up (see fig. 10). While folding down, make sure the support of the foot plate is locked into the receiver.
 - **Only for leg supports with single-panel foot plate:** Make sure the support of the foot plate is locked into the receiver. (not illustrated)
 - **Only for leg supports with segmented foot plates:** Make sure the fastening mechanism of the foot plate engages (see fig. 11, item 1).

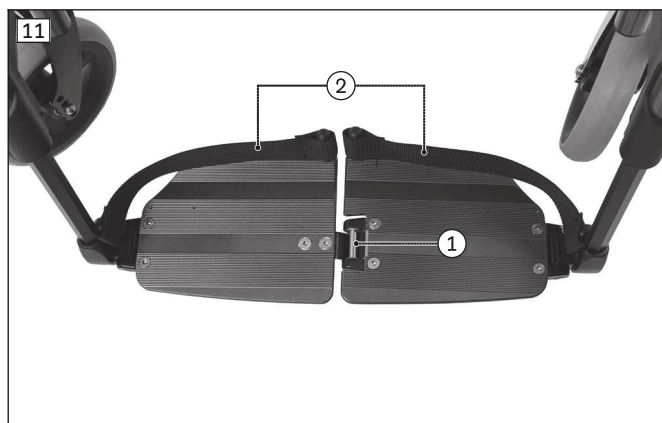

7.3.2 Removing and attaching the leg supports

Removing the leg supports

- 1) Fold the foot plate up.
- 2) Pull back the release lever (see fig. 12, item 1).
- 3) Remove the leg support:
 - **Frame model XXL 2 contoured:** Fold the leg support out by **90°** (see fig. 12, item 2). Only now can the leg support be lifted up and off.
 - **Frame model XXL 2:** The leg support can be removed immediately without swinging it away.

Attaching the leg supports

- 1) Insert the leg support:
 - **Frame model XXL 2 contoured:** Hold the leg support **90°** out to the side and insert it into the leg support retainer (see fig. 12, item 2).
 - **Frame model XXL 2:** The leg support can be inserted into the leg support retainer immediately without swinging it away.
- 2) Swing the leg support into the direction of travel until it engages.
- 3) Fold the foot plate down.

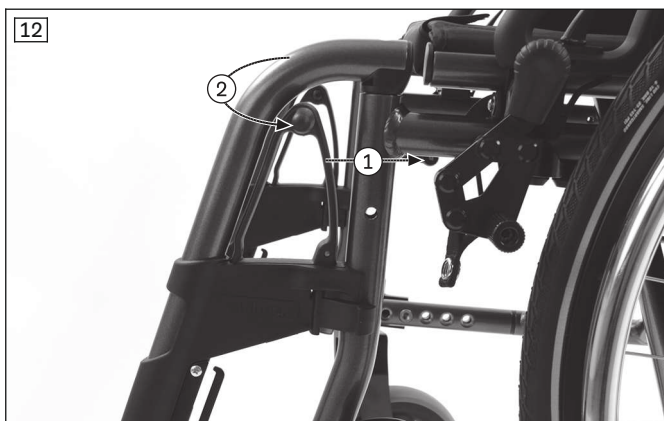

7.3.3 Removing and fastening the calf strap

The calf strap offers additional support for the user's legs. It also prevents the feet from sliding off the foot plate into the danger area. The calf strap can be removed for cleaning.

Attaching the calf strap

- 1) Open all hook-and-loop closures.
- 2) Pass the calf strap through the eyelets on the swivel segments (see fig. 14, item 1).
- 3) Adjust the length and fasten the hook-and-loop closure (not pictured).

Removing the calf strap

- 1) Open all hook-and-loop closures.
- 2) Remove the calf strap from the frame tube.

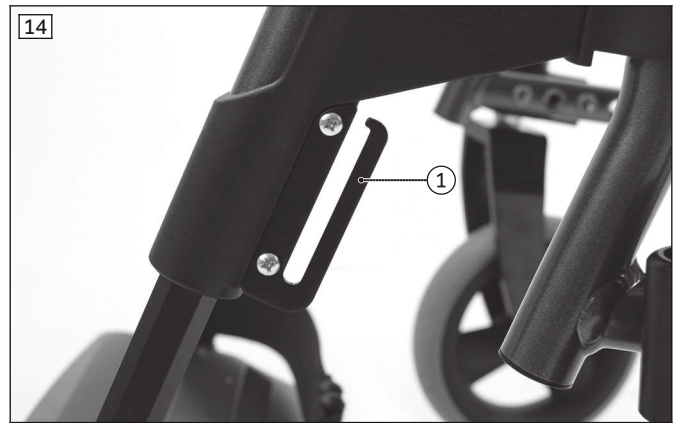
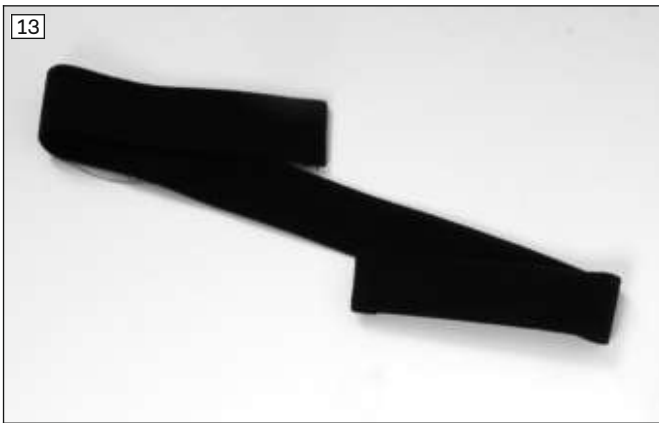

7.3.4 Adjusting the leg support

Further adjustments may be made only by qualified personnel.

7.4 Seat and back upholstery

⚠ WARNING

Seat cushions and back support pads may ignite

Burns due to user error

- ▶ The seat and back support upholstery as well as seat cushions, padding and covers fulfil the normative requirements for flame resistance. However, they may still ignite if fire is handled improperly or negligently.
- ▶ Keep away from all ignition sources, especially lit cigarettes.

⚠ CAUTION

Wear of the seat and back upholstery

Loss of functionality due to prohibited continued use

- ▶ Have the seat and back upholstery replaced immediately in case of damage.

The product is equipped with seat and back upholstery. Hook-and-loop fasteners on the seat upholstery are used to attach the seat cushion. The seat cushion ensures pressure relief during use of the wheelchair. It was chosen by qualified personnel according to the needs of the user.

The seat upholstery on model XXL 2 has an additional pocket with a hook-and-loop closure under the seat bottom (see fig. 15).

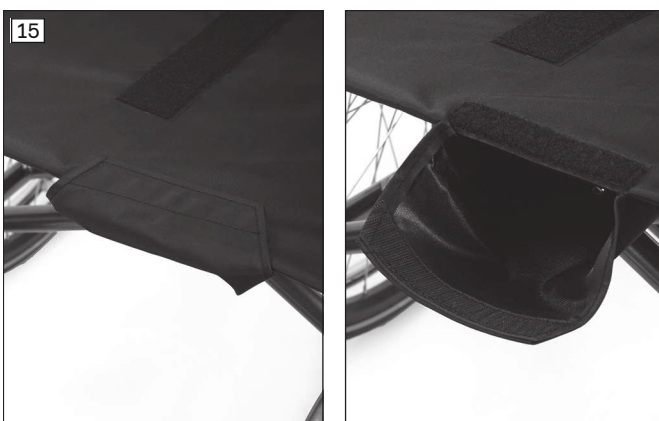

7.4.1 Removing and fastening the seat cushion

The seat cushion can be removed for cleaning.

After cleaning, the seat cushion is placed on the seat upholstery and secured against sliding by pressing it onto the hook-and-loop fastener on the seat upholstery.

7.5 Backrest

⚠ WARNING

Incorrect use of back support angle adjustment

Falling, tipping over due to operation without anti-tipper

- ▶ Note that adjusting the back support angle shifts the centre of gravity. Only use the back support angle adjustment with the anti-tipper activated.
- ▶ Drive in street traffic only with a vertical back support.

The product can be equipped with a fixed or optionally an angle-adjustable back support.

Height-adjustable/adaptable back support (not illustrated)

The different versions of the back support permit height adjustments in **25 mm** increments within an adjustment range of **250 to 500 mm**.

Angle-adjustable back support (see fig. 16)

The inclination of the back support to the seat bottom can be adjusted by qualified personnel from **-9° to +15°** in 6° increments. The angle-adjustable back support also permits an extremely small folding size.



7.6 Side panels

⚠ CAUTION

Pinching at the side panels

Pinching, crushing due to lack of caution in danger areas

- ▶ Pay attention not to pinch parts of your body between the side panel or frame parts.

The side panels protect the user and his/her clothing from getting dirty.

If armrests have been installed on the wheelchair, they offer the user additional support for the forearms.

The wheelchair can be equipped with various side panels:

Adjustable side panel with protection against cold (see fig. 17)

The aluminium side panel can be quickly adapted horizontally and vertically to changed drive wheel positions.

Adjustable clothing guard with protection against cold (see fig. 18)

Many wheelchair users are familiar with the problem of clothes coming into contact with the drive wheels and getting dirty. The clothing guard prevents this. It is horizontally and vertically adjustable and can therefore be adapted to the position of the drive wheel.

Side panel with height-adjustable forearm support (see fig. 19)

The side panels can be swung away to the rear and removed for transfer. The height of the forearm support can be adjusted without the use of tools. The forearm support is offered in the short, long and asymmetrical versions.

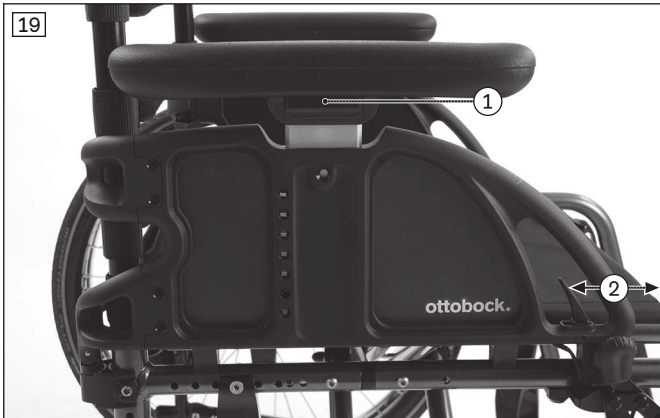

7.6.1 Adjusting the height of the forearm support

Side panel with height-adjustable forearm support

- 1) Pull up the release lever under the arm support (see fig. 19, item 1).
- 2) Slide the forearm support to the desired position.
- 3) Let go of the release button. The forearm support locks into place automatically.

7.6.2 Removing the side panels

INFORMATION

Side panels with permanent screw connections cannot be removed.

For easier entry and transport, the side panel with height-adjustable forearm support can be removed.

Removal

- 1) Push the release lever forward (see fig. 19, item 2).
- 2) Fold back the side panel.
- 3) In the vertical position, pull the side panel up and off.

Attachment

- 1) Insert the side panel into the holder.
- 2) Fold the side panel forwards. The locking mechanism engages automatically.

7.6.3 Adjusting an arm support with swivel unit

INFORMATION

After adjusting the swivel unit, please always make sure that the lock pins have safely snapped in place.

The swivel unit allows the support angle and the rotation setting of an arm support to be adjusted individually.

Adjusting the support angle

- 1) Pull the release button outwards (see fig. 20, item 1).
- 2) Lift up the arm support at the front end and adjust it to the desired angle (see fig. 20, item 2).

- 3) Let go of the release button. The arm support will be secured in its position.

Adjusting the rotation setting in 15° increments

- 1) Pull the release button downwards (see fig. 21, item 1).
- 2) Move the arm support to the desired rotation setting (see fig. 21, item 2).
- 3) Let go of the release button. The arm support will be secured in its position.

Continuously adjusting the rotation setting

- 1) Pull the release button downwards (see fig. 21, item 1).
- 2) Turn the release button 90° (not pictured). The arm support can be rotated freely in this position.
- 3) Move the arm support to the desired rotation setting (see fig. 21, item 2).
- 4) Let go of the release button. The arm support will be secured in its position.

Adjusting the depth of the arm support

- 1) Loosen the Allen head screws under the arm support (not pictured).
- 2) Slide the arm support to the desired depth.
- 3) Re-tighten the Allen head screws under the arm support.

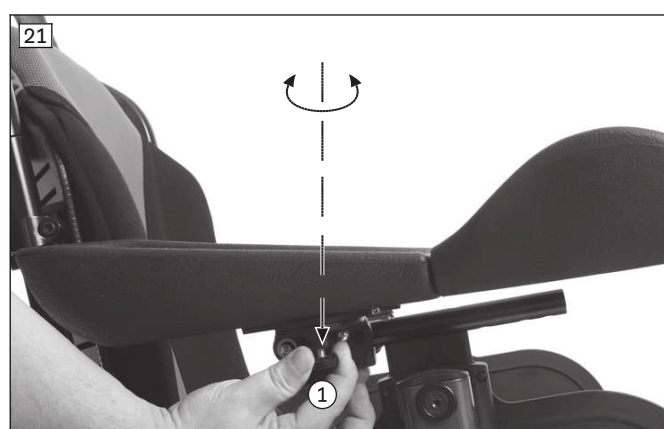

7.7 Push handles

The push handles make pushing the wheelchair easier for the attendant.

Some of the push handle designs allow the height to be adjusted to suit the needs of the attendant.

7.7.1 Adjusting the height of the push handles

To enable ergonomic pushing by the attendant, the wheelchair can be equipped with height-adjustable push handles.

- 1) Release the clamping lever.
- 2) Adjust the height of the push handle.

INFORMATION: Adjust both push handles to the same height.

- 3) Engage the clamping lever.



7.7.2 Removing the push handles

Push handles of the “height-adjustable, removable” type can be removed from the back support tube when needed.

Removing/installing the push handles

- 1) Release the clamping lever (see fig. 24, item 1).
 - 2) Push in the tripod spring (see fig. 24, item 2) and pull the push handle up and out of the adapter (see fig. 24, item 3).
 - 3) To install, push in the tripod spring again and insert the push handle into the adapter.
 - 4) Firmly close the clamping lever (see fig. 24, item 1).
- Both push handles must be installed at the same height.



7.8 Stabiliser bar

The stabiliser bar between the push handles increases the wheelchair's stability, especially in case of high loads. It has to be opened before folding the wheelchair.

Please note: Using the stabiliser bar for pushing and pulling the wheelchair is not permitted. Always use the push handles for this purpose.

Opening the stabiliser bar

- 1) Open the star handle on the right side (see fig. 26, item 1).
- 2) Fold the stabiliser bar down (see fig. 26, item 2).

Closing the stabiliser bar

- 1) Fold the stabiliser bar up until the opening is against the screw of the star handle.
- 2) Hand-tighten the star handle.



7.9 Drive wheels

⚠ WARNING

Improper assembly of removable wheels

Tipping, falling over of the user due to wheels coming off

- ▶ After each assembly, verify the proper fit of the removable wheels. The quick-release axles must be firmly locked in the wheel attachment.

⚠ WARNING

Defective tyres

Accidents/falling due to poor traction, reduced braking force or lack of manoeuvrability

- ▶ Maintain sufficient tyre pressure. Note the information in the section "Technical data" or on the tyre sidewall.
- ▶ Ensure that the pressure is the same in both tyres.
- ▶ Ensure that the tyres have sufficient tread depth.

⚠ CAUTION

Reaching into exposed drive parts

Crushing, pinching due to incorrect handling

- ▶ Do not reach between the drive wheel and wheel lock or drive wheel and side panel when driving the product.
- ▶ Do not reach into the spokes of the rotating drive wheel while riding in the product.

⚠ CAUTION

Heat development when braking with handrims

Burns due to insufficient hand protection

- ▶ Wear wheelchair gloves when travelling at high speeds.

The wheelchair is moved, steered, braked and stopped with the help of the handrims on the drive wheels. To make transport easier, drive wheels with quick-release axle can be taken off the wheelchair.

7.9.1 Removing and mounting the drive wheels

⚠ CAUTION

Incorrect removal/attachment of the wheels

Tipping, falling due to incorrect installation

- ▶ The user is not permitted to sit in the wheelchair during wheel replacement.
- ▶ For changing wheels, set the wheelchair onto a solid surface.
- ▶ To change the wheels, secure the wheelchair against tipping over or rolling away.
- ▶ If the drive wheel does not lock securely or has too much sideways play, contact the qualified personnel promptly.

- 1) Release the wheel lock.
- 2) Use your thumb to press in the push-button on the quick-release axle (see fig. 27, item 1).
- 3) Remove or mount the drive wheel.

After mounting: The drive wheels must not be removable after releasing the push-button on the quick-release axle.



7.9.2 Spoke protector

The spoke protector prevents the fingers from getting caught in the wheel spokes.

7.10 Caster wheels and caster forks

⚠ WARNING

Failure of caster wheels or caster forks

Falling, severe injury due to the wheelchair tipping over

- ▶ Regularly inspect the caster wheels and caster forks for damage.
- ▶ Regularly clean and oil the caster wheel axles and the threaded axles on the caster forks, especially in case of stiffness.
- ▶ Inform the responsible qualified personnel in case of permanent changes to the driving characteristics.

⚠ CAUTION

Incorrect caster wheel position when leaning forward in the wheelchair

Tipping over, falling due to incorrect caster wheel positioning

- ▶ Prior to activities that require you to bend forward in the wheelchair (e.g. tying your shoes), maximise the stability of the wheelchair.
- ▶ In order to do so, push the wheelchair backwards until the caster wheels turn forward.

The combination of caster wheels and caster forks ensures the ability to hold a straight line and navigate bends securely.

The caster wheels and caster forks have been chosen by the qualified personnel according to the needs of the user.

Some options can expand the functions of the caster forks and caster wheels:

Caster wheel adapter for high front seat heights (see fig. 28)

Increases the front seat height by **35 mm**. Expands the adjustment range of the lower leg lengths. Also offers more freedom of movement for the feet due to caster wheels being positioned further to the outside.

Caster wheel adapter for low front seat heights (see fig. 29)

Reduces the front seat height by **35 mm**. Also offers more freedom of movement for the feet due to caster wheels being positioned further to the outside.



Alternative caster wheels

Standard caster wheels (see illustration above) or alternative caster wheels may be installed (e.g. Froglegs caster wheels with aluminium hubs (see fig. 30)).

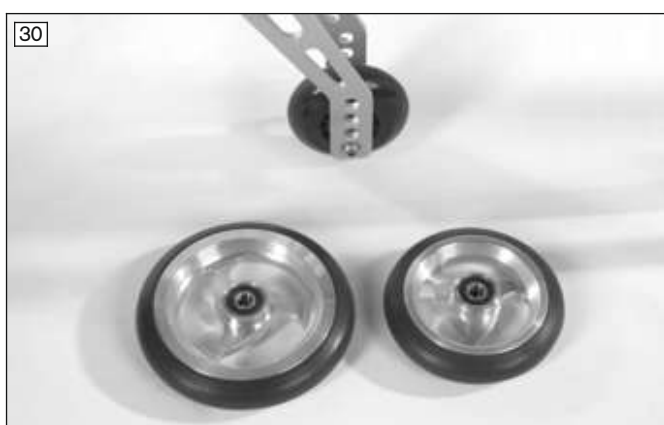

7.10.1 Approach in case of stiffness

In case of stiffness, the caster wheel axles should be cleaned and oiled.

Oiling the caster axle

- 1) Remove dirt (such as hairs) from the caster axle between the caster wheel and caster fork.
- 2) Lubricate the caster axle between the caster wheel and caster fork with a few drops of thin, resin-free oil (sewing machine oil).

7.11 Wheel locks

⚠ WARNING

Improper use of the wheel lock

Falls due to abrupt braking, rolling away of the product, crushing of hands

- ▶ Do not use the wheel lock as a driving brake.
- ▶ Always engage the wheel lock on both sides.
- ▶ Engage the wheel lock to prevent the product from moving when it is parked on uneven ground or during transfers (e.g. into a car).
- ▶ Do not reach between the rear wheel and the wheel lock when driving the product.
- ▶ Ensure that the knee lever wheel lock is properly adjusted (max. **5 mm** gap between wheel lock bolt and tyre). The wheel lock bolt must lock the drive wheel securely when stationary.
- ▶ Please contact the qualified personnel who adjusted your product for readjustment of the wheel lock.

The wheel locks secure the parked wheelchair against rolling away.
Different wheel lock types may be installed depending on the order.

7.11.1 Using the wheel locks

Activating and deactivating the knee lever wheel lock

- 1) Push the handle of the knee lever wheel lock forward (see fig. 31).
→ The wheel lock bolt secures the wheel.
- 2) Pull the wheel lock lever upwards (see fig. 31).
→ The wheel lock lever releases the wheel.

Plug-on wheel lock lever extension (see fig. 32)

The wheel lock lever extension facilitates use of the knee lever wheel lock. For easier transfer, the wheel lock lever can be folded.



7.11.2 Drum brake

The drum brakes allow the attendant to slow the wheelchair easily and safely by activating the wheel lock lever on the push handles.

Activating/deactivating the drum brake

- 1) Pull the brake lever (see fig. 33, item 1).
- 2) If necessary, secure the brake lever by additionally actuating the lock slide (see fig. 33, item 2).
- 3) Deactivate the wheel lock by actuating the wheel lock lever again or pressing the lock slide.

The drive wheels can still be removed via the quick-release axles when the wheel lock lever is released (see fig. 34).

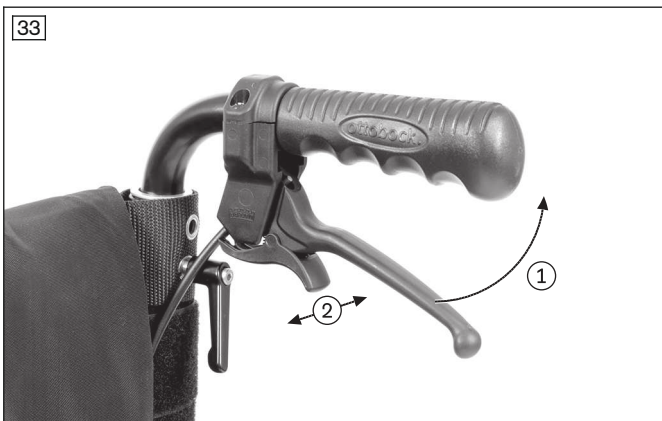

7.11.3 Knee lever wheel lock for user and attendant

This wheel lock type can be used by both the user and an attendant.

INFORMATION

- ▶ Operation of the wheel lock by the user is the same as for the knee lever wheel lock described above.
- ▶ Operation of the wheel lock levers by the attendant is the same as for the drum brake described above.

Activation/deactivation by the user

- 1) Push the handle of the knee lever wheel lock forward (see fig. 31).
→ The wheel lock bolt secures the wheel.
- 2) Pull the wheel lock lever upwards (see fig. 31).
→ The wheel lock bolt releases the wheel.

Activation/deactivation by the attendant

- 1) Pull the wheel lock lever (see fig. 33, item 1).
- 2) Secure the wheel lock lever by additionally actuating the lock slide (see fig. 33, item 2).
→ The wheel lock bolt secures the wheel.
- 3) Deactivate the wheel lock by actuating the wheel lock lever again or pressing the lock slide (see fig. 33, item 1/2).
→ The wheel lock bolt releases the wheel.

7.11.4 Knee lever wheel lock for one-handed operation (double handrims)

Depending on the installation, this wheel lock type can be operated either on the right or left side and ensures safe locking of both rear wheels with a pull-wire system.

Activating/deactivating the knee lever wheel lock for one-handed operation**INFORMATION**

Note that when the wheel lock lever extension option is chosen, the lever extension must always be attached when releasing or engaging the wheel lock.

- 1) Push the handle of the knee lever wheel lock forward (see fig. 35).
→ The wheel lock bolt secures the wheel.
- 2) Pull the wheel lock lever upwards (see fig. 35).
→ The wheel lock bolt releases the wheel.

**7.12 Frame accessories****7.12.1 Anti-tipper****⚠ WARNING****Incorrectly adjusted anti-tipper**

Tipping over, falling of the user due to errors in handling the product

- ▶ If only one attendant helps in overcoming steps, the attendant must first deactivate the anti-tipper so that it cannot collide with the steps during transport.
- ▶ The attendant must activate the anti-tipper again after overcoming the steps.

⚠ WARNING**Anti-tipper not activated**

Tipping over, falling of the user due to improper operation of a safety device

- ▶ Ensure that an installed anti-tipper is activated before travelling over obstacles and on inclines.
- ▶ The anti-tipper has to engage audibly prior to use. Proper engagement must be checked by the user or an attendant.
- ▶ The use of an anti-tipper is highly recommended for transfemoral amputees and inexperienced users.

⚠ WARNING**Incorrectly adjusted anti-tipper**

Risk of falling as a result of incorrectly adjusted anti-tipper.

- ▶ The anti-tipper may only be adjusted by qualified personnel.

The anti-tipper prevents the wheelchair from tipping backwards when overcoming obstacles and going uphill.

7.12.1.1 Activating and deactivating the anti-tipper

A mounted anti-tipper must always be active.

When overcoming obstacles (such as steps and curbs that are not lowered) **upwards**, the anti-tipper rollers contact the ground.

When overcoming obstacles (such as steps and curbs that are not lowered) **downwards**, the anti-tipper has to be deactivated by the user or attendant to avoid damaging the anti-tipper.

Activation

- 1) The anti-tipper is pressed down with the hand or foot (see fig. 36, item 1; see fig. 37, item 1).
- 2) Swing the anti-tipper back and allow it to engage (see fig. 36, item 2; see fig. 37, item 2).

Deactivation

- 1) From above, press on the anti-tipper with the hand or foot until it disengages (see fig. 38, item 1; see fig. 39, item 1).
- 2) Rotate the anti-tipper forward by **180°** and release it (see fig. 38, Pos. 1; see fig. 39, Pos. 1).

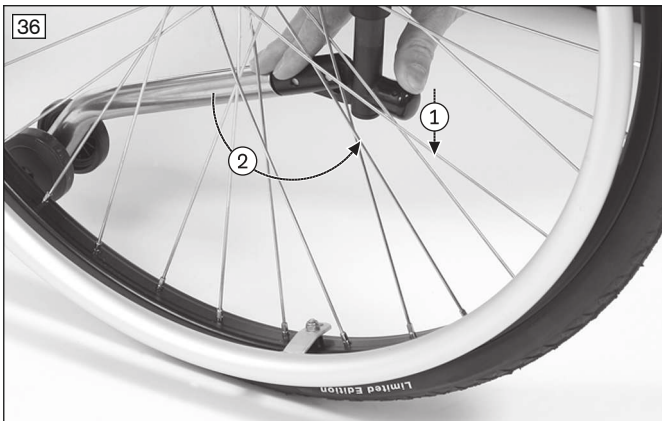

7.12.2 Tip-assist

The tip-assist makes overcoming obstacles easier for the attendant.

7.12.2.1 Using the tip-assist

For this wheelchair type, the tip-assist is integrated into the frame (see fig. 40).

- 1) At an obstacle, place one foot on the tip-assist and push down.
- 2) Slightly tip the wheelchair by simultaneously pressing down on the push handles.



7.13 Front frame

The product can be delivered with two front frame versions:

- **Standard front frame:** The wheelchair features a straight front frame without abduction (see Page 6).
- **Abduction front frame:** The frame is contoured to the outside by **20 mm** on both the left and right sides (not illustrated). This makes the entry area larger.

7.14 Lap belt (seat belt)

⚠ CAUTION

Incorrectly adjusted lap belt

Malpositions, illness, falling of the user due to installation/adjustment errors

- ▶ Do not modify the settings established by the qualified personnel. In case of problems with the adjustments (unsatisfactory sitting position) please contact the qualified personnel who fitted the product.
- ▶ The lap belt has to fit closely but not too tightly so the user is not injured. It should be possible to slide two fingers comfortably between the belt and thigh.
- ▶ Have the settings of the belt system checked regularly. Adjustments may be required due to the growth of the user or because of changes in the course of the disease or different clothing.

The lap belt (seat belt) prevents the user from slipping and supports positioning.

It is installed on the product by qualified personnel if needed and adapted to the requirements of the user.

Information about subsequent acquisition and mounting is provided by the qualified personnel that handed over the product.

Using the lap belt

- 1) Open the buckle.
- 2) Place the user in an upright, 90° seated position (if physiologically possible). Ensure that the back is up against the back support pad (if physiologically possible).
- 3) Close the buckle.
- 4) The lap belt should be at an angle of about **60°** to the seat bottom. The belt strap should run across the thighs in front of the pelvic bones (see fig. 41).

Possible errors

- The lap belt is positioned above the user's pelvis in the area of the soft part of the stomach.
- The user does not sit upright in the seat.

- If the lap belt is too loose, the user can shift/slide out to the front.
- During the installation/adjustment, the lap belt is routed over parts of the seating system (e.g. over forearm supports or seat pads). This causes the lap belt to lose its retaining function.

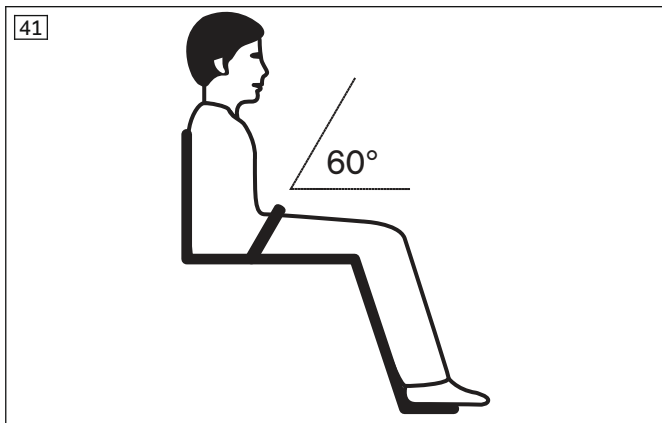

7.15 Transport wheels

⚠ CAUTION

Knee lever wheel lock when the drive wheels are removed

Risk of accident, falling due to loss of functionality of the knee lever wheel lock

- ▶ Note that a wheelchair with transport wheels can only be braked by an attendant.

⚠ CAUTION

Incorrect height setting

Risk of tipping or falling due to the sloped product setting

- ▶ Always adjust the height equally on both sides.

The transport wheels (see fig. 42) permit movement through very narrow passages (e.g. in trains or aircraft).

Transport wheels take the place of the drive wheels. In order to move, an attendant is required to push the wheelchair.

7.15.1 Using the transport wheels

> Prior to use, verify whether the transport wheels have been set to the same height.

1) Remove the drive wheels.

Whenever possible, this should be done when the user is not sitting in the wheelchair. If the user is sitting in the wheelchair, proceed as follows:

2) The first attendant holds the wheelchair in a stable position so that the drive wheels are relieved in turn.

3) The second attendant carefully removes the first and second drive wheel one after the other.

→ The wheelchair can now be pushed on the transport wheels.



7.16 Crutch holder with hook-and-loop fastening strap

The crutch holder with hook-and-loop fastening strap allows crutches to be attached to the wheelchair.



7.17 Head and neckrest

Head/neckrests or headrests make it possible to support the head in case of various severe disability indications. The head/neckrests or headrests consist of polyurethane foam and can be cleaned with mild soap and water.

The option is installed on the product by qualified personnel if needed and adapted to the requirements of the user. The user may adjust the movable blocks of the headrest according to his/her preferences.

To do so, adjust the movable blocks into the desired position and tighten the wrench bolts to fix the headrest in place.

7.18 Tray

⚠ WARNING

Inflammable product

Burns due to user error

- ▶ The product is flame retardant. Nevertheless, the possibility that it may catch fire cannot be entirely excluded in case of exposure to an ignition source. Therefore, the utmost caution must be exercised in the vicinity of an open flame.
- ▶ Keep away from all ignition sources, especially lit cigarettes.

⚠ CAUTION

Improper adjustment

Crushing or pinching due to adjustments which are too tight

- ▶ Do not pinch the user when sliding in the product.

⚠ CAUTION

Driving with objects on the tray top

Injuries due to unsecured objects

- ▶ Remove all objects from the tray top prior to travelling.

⚠ CAUTION

Improper lifting by attendants

Tipping over, user falls due to lifting by removable components

- ▶ The product must not be lifted by the tray.

NOTICE

Overloading

Damage to the product due to user error

- ▶ Do not load the tray with heavy objects.
- ▶ No persons may sit or lean on the tray.

The tray serves as a supporting surface during meals, when working or when playing. The clear material allows visibility of the legs and correction of the sitting posture.

Prior to use in a vehicle for transporting persons with reduced mobility, the tray has to be removed.

Mounting/removing the tray

- 1) Slide the tray on to the armrests.
- 2) Pull the tray off the armrests.

Always guide the tray parallel to the armrests to avoid canting.

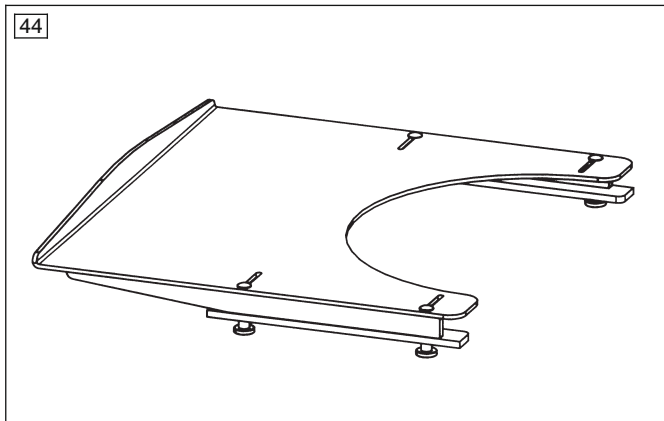

7.19 Additional options

The product may be equipped with additional options.

The options are firmly mounted to the product by qualified personnel or the manufacturer and are pre-adjusted by qualified personnel at delivery.

7.20 Disassembly and transport

CAUTION

Exposed pinch points

Crushing, pinching due to incorrect handling

- ▶ When folding the wheelchair out or together, only grip by the specified components.

NOTICE

Deformation when folded

Damage to the product, problems unfolding due to unallowable loads

- ▶ Never place heavy objects on the folded product.

INFORMATION

- ▶ When transporting the wheelchair in vehicles, fold it up and remove the wheels and leg supports if necessary.
- ▶ Follow the IATA (International Air Transport Association) rules and those of the relevant airline when transporting the wheelchair in an aircraft. Inform the airline several days before your flight. Use the SSR (special service request) codes to describe the type of limited mobility if necessary. You can for example research these on the Internet.

The wheelchair must be prepared for transport in a passenger vehicle.

- 1) Fold up the leg supports (see Page 14). To make the wheelchair more handy for transportation, the leg support can also be taken off (see Page 15).
- 2) **If necessary:** Detach the seat cushion from the hook-and-loop fastener.
- 3) Pull up the seat upholstery until the wheelchair folds together (see fig. 45).
- 4) Fasten the safety strap (see fig. 46).
- 5) Remove the drive wheels (see Page 21).
- 6) Place the wheelchair in the vehicle.



7.21 Use in vehicles for transporting persons with reduced mobility

⚠ WARNING

Improper use in vehicles for transporting persons with reduced mobility

Risk of serious injury when using the product as a seat

- ▶ The product has **not** been approved by the manufacturer for use as a seat in vehicles for transporting persons with reduced mobility.
- ▶ In vehicles for transporting persons with reduced mobility, only use the seats installed in the vehicle with the corresponding personal restraint systems.
- ▶ Information on the current status of our measures is available from the qualified personnel.

The Avantgarde XXL 2 wheelchair has not been approved by the manufacturer for use as a seat in vehicles for transporting persons with reduced mobility.

7.22 Care

⚠ CAUTION

Lack of or improper cleaning

Health hazard due to infections, damage to the product due to user error

- ▶ Clean the product at regular intervals.
- ▶ Do not clean the product with a jet of water or a pressure washer. The penetration of water can cause corrosion and subsequent malfunctions.
- ▶ To avoid contamination with germs, clean seat cushions and back support upholstery whenever they get soiled.
- ▶ Check the driving behaviour of the product after cleaning it.

7.22.1 Cleaning

Clean the product regularly depending on the degree of soiling and frequency of use, **at least 1x per month**:

7.22.1.1 Cleaning by hand

- 1) Clean the padding and upholstery with warm water and a mild detergent.
- 2) Remove any spots with a sponge or a soft brush.
- 3) Rinse with clear water and let the components dry.

Important information on cleaning

- Clean plastic parts, frame parts and the chassis and wheels with a mild cleaner and a damp cloth. Dry thoroughly afterwards.
- Do not use any aggressive cleaners, solvents or hard brushes etc.
- Do not spray the product with a pressure washer.

7.22.1.2 Cleaning the seat cushion

Standard seat cushion

- ▶ Clean the seat cushion according to the attached care label.

Seat cushion with foam core

- 1) Open the zipper and remove the foam core (see fig. 47).
- 2) Clean the cover according to the attached care label.
- 3) Wash all foam parts by hand at **40°C** using a mild, environmentally friendly detergent. Allow to air dry.
- 4) Reinsert the foam core with proper alignment. Close the zipper.



Important information on cleaning

- For more information on cleaning seat cushions, see the care instructions on the product or the supplied instructions for use.

7.22.1.3 Cleaning belts/straps

Cleaning a belt system with metal closure

INFORMATION

Observe the washing recommendations on the product and the information in the corresponding instructions for use provided for the product.

- Straps with metal closures **may not be washed in the washing machine** as the penetration of water could cause corrosion and subsequent malfunctions.
- Clean the belt straps by gently dabbing them with warm soapy water (with some disinfectant) or carefully wipe with a dry, clean, absorbent cloth.

Cleaning a belt system with plastic closure

- Depending on the model, belts/straps with plastic buckles can be washed in the washing machine between **40 °C** and **60 °C**.
- Recommendation: Use a laundry bag or net and mild detergent.

INFORMATION

Alternatively, the belt straps can be cleaned by gently dabbing them with warm soapy water (with some disinfectant) or carefully wiped with a dry, clean, absorbent cloth.

Additional cleaning instructions

- Allow the belts to air dry. Ensure that the belts and pads are completely dry before installation.
- Do not expose the belts to direct heat (e.g. sunshine, stove or radiator).
- Do not iron or bleach the belts.

7.22.2 Disinfection

- 1) Thoroughly clean the pads and handles before disinfecting.
- 2) Wipe all parts of the wheelchair with a disinfectant.

Important information about disinfecting

- If the product is used by more than one person, using a conventional disinfectant is required.
- Only use colourless water-based disinfectants. Observe the instructions for use provided by the manufacturer.

8 Maintenance and repair

8.1 Maintenance

WARNING

Insufficient maintenance

Severe user injuries, damage to the product due to failure to observe maintenance intervals

- ▶ Only carry out the maintenance tasks described in this section. All other maintenance and service tasks may only be carried out by qualified personnel.
- ▶ The functionality and operating safety of the product must be verified and a service performed at least **once per year**.
- ▶ For users with a changing anatomy (for example body dimensions, weight) or users with a changing clinical picture, have the product inspected, adjusted and serviced at least **once every six months**.

- The function of the product should be checked **before each use**.
- The product may not be used if defects are noted. This applies in particular in case of instability of the product or altered driving characteristics as well as problems with the user's seating position or the stability of the seat. Inform the qualified personnel promptly for the rectification of defects.
- This also applies if loose, worn, bent or damaged components, cracks in the frame or broken frame components are identified.
- Some maintenance tasks can be carried out to a certain extent by the user at home (see the sections "Maintenance intervals" and "Maintenance tasks").
- Failure to maintain the product can lead to injuries for the user of the product.

8.1.1 Maintenance intervals

The functions described below must be checked by the user or an attendant at the specified intervals:

Inspection task	Before each use	Monthly	Quarterly
Functional test of the wheel locks	X		
Sagging of the seat or back support upholstery		X	
Stability of the leg supports		X	
Visual inspection of wear and tear parts (e.g., tyres, bearings)		X	
Soiling of bearings		X	
Damage to the handrim		X	
Air pressure (see tyre sidewall for specifications)		X	
Wear and tear of the folding mechanism		X	
Check of the spoke tension on the drive wheels			X
Check of all screw connections			X
Check the legibility of all labels and markings on the product		X	

8.1.2 Maintenance tasks

To ensure smooth operation at all times, users or attendants with some technical skills can maintain some parts of the product:

- Screw connections must be periodically checked for tightness, especially during the initial period of use or after adjustments have been made to the wheelchair. If a screw connection loosens repeatedly, contact the qualified personnel promptly.
- Particles of dirt and hair accumulate on the caster wheel axle and threaded axle of the caster fork over time. This makes the steering stiffer. Regularly remove dirt and oil the axles. See the section "Approach in case of stiffness".
- The drive wheels are equipped with a quick-release axle system as standard equipment. To keep this system operational, ensure that no dirt adheres to the quick-release axle or receiver bushing. Periodically lubricate the quick-release axle lightly with thin, resin-free oil (sewing machine oil).
- If the wheelchair becomes wet, it should be rubbed dry again.

8.2 Repair

⚠ WARNING

Prohibited repairs

Severe user injuries, damage to the product due to adjustment and installation errors

- ▶ Only carry out the repairs described in this section. All other repairs may only be carried out by the qualified personnel.

8.2.1 Inner tube, rim tape and tyre replacement

⚠ CAUTION

Improper tyre replacement

Injuries to the user due to incorrect installation, product damage

- ▶ No person is permitted to sit in the wheelchair during tyre replacement
- ▶ Before removing a wheel, support the product so it cannot tip over.
- ▶ Always replace the tyres in pairs. Two differently worn tyres affect the directional stability of the wheelchair.

INFORMATION

When driving outdoors, always carry a repair kit and tyre pump (when using pneumatic tyres) in case of emergency.

Suitable tyre pumps are listed on the order form and are supplied with the product. An alternative is tyre foam, which fills your tyre and then hardens (available from bicycle shops, etc.).

Repairing flat tyres requires only the necessary tools and users may change tyres themselves if they wish:

Removal and preparing for installation

- 1) Carefully remove the tyre from the rim using appropriate tools.
INFORMATION: Take care not to damage the rim or the inner tube.
- 2) Unscrew the valve nut from the valve and remove the tube.
- 3) Repair the tube according to the directions in the repair kit or replace it with a new tube.
- 4) Before fitting the tyre again, inspect the rim bed and tyre inner wall for foreign objects. This could have caused the puncture.
- 5) Before installing the tube, check that the rim band is in proper condition. The rim band protects the tube from being damaged by the ends of the spokes.



Replacing the rim band (only when necessary)

- 1) If the rim band needs to be replaced, remove it from the rim.
- 2) Install the new rim band on the inside of the rim, making sure the valve opening is in the right position.
- 3) Glue the rim band in place if this is intended. Ensure that all spoke ends are covered.

Installing the tube and tyre

- 1) Behind the valve, push one side of the tyre over the edge of the rim.
- 2) Slightly inflate the tube until it starts to assume its round shape.
- 3) Unscrew the valve nut from the tube and push the valve through the valve opening in the rim.

- 4) Insert the tube into the tyre.
- 5) Mount the other side of the tyre on the rim, starting from the position across the valve. Ensure that the tube is not pinched between the tyre and rim during this process.



Inflating the tube

- 1) Ensure that the valve is positioned perpendicularly for proper positioning of the tube and tyre in the region of the valve.
- 2) Firmly screw on the valve nut.
- 3) Inflate the tube so that the tyre can still be pressed in easily with your thumb.
INFORMATION: If the circumferential lines on the two sides of the tyre are both at an even distance from the rim, the tyre is centred. If not, let some air out and realign the tyre.
- 4) Inflate the tube to the maximum pressure specified by the tyre manufacturer (see information printed on the tyre sidewall).
- 5) Firmly screw the valve cap onto the valve.

9 Disposal

9.1 Disposal information

Return the product to the qualified personnel for disposal.

All components of the product must be disposed of properly in accordance with the respective national environmental regulations.

10 Legal information

All legal conditions are subject to the respective national laws of the country of use and may vary accordingly.

10.1 Liability

The manufacturer will only assume liability if the product is used in accordance with the descriptions and instructions provided in this document. The manufacturer will not assume liability for damage caused by disregarding the information in this document, particularly due to improper use or unauthorised modification of the product.

10.2 Warranty

Further information on the warranty terms and conditions can be obtained from the qualified personnel that has fitted this product or the manufacturer's service (see inside back cover for addresses).

10.3 Service life

Expected lifetime: **4 years**

The design, manufacturing and requirements for the intended use of the product are based on the expected lifetime. These also include the requirements for maintenance, ensuring effectiveness and the safety of the product.

11 Technical data

INFORMATION

- ▶ Much of the technical data below is given in mm. Please note that product settings – unless otherwise specified – cannot be adjusted in the mm range but only in increments of approx. **0.5 cm** or **1 cm**.
- ▶ Note that the values achieved during adjustment may deviate from the values specified below. The deviation can be **±10 mm** and **±2°**.

INFORMATION

- ▶ Some of the measurements indicated below are values that were theoretically determined.
- ▶ Note that not all adjustment possibilities can be used with all product versions. Furthermore, the adjustment combinations are limited by the compact frame geometry.
- ▶ Technical changes and tolerances are reserved by the manufacturer.

	Avantgarde XXL 2
Max. load [kg]	180
Transport weights [kg] ¹⁾	Frame: from 11.3 24" drive wheel: from 1.3 (including quick-release axle)
Min. tyre pressure [bar] ²⁾	7
Permissible tyre type – drive wheels	Pneumatic tyres, PU tyres
Permissible tyre type – caster wheels	Solid rubber, pneumatic tyres, soft caster
Maximum permissible inclination [°]/[%] ³⁾⁴⁾⁵⁾	7 / 12.3

¹⁾ The specified weights vary according to the selected options and model.

²⁾ Varies according to tyre option; see the marking on the tyre wall.

³⁾ Also applies for parking with wheel lock engaged.

⁴⁾ Applies to all directions (upwards, downwards, sideways).

⁵⁾ In accordance with ISO 7176-1.

Additional information

Avantgarde XXL 2	Minimum	Maximum
Weight [kg] ¹⁾	14 ²⁾	17 ²⁾
Overall length with leg supports [mm]	790	1140
Overall width [mm]	695	850
Folding size, length with leg supports [mm]	790	1140
Folding size, width [mm]	320	380
Folding size, height [mm]	700	1053
Seat bottom angle (difference between front/rear seat height) [°]	Approx. 15	
Effective seat depth [mm]	400	560
Effective seat width [mm]	460	620
Front seat height [mm]	460	530
Rear seat height [mm]	410	530
Back support angle (in reference to perpendicular to the seat bottom) [°]	-9	+15
Back support height [mm]	250	500
Distance from leg support to seat [mm]	320	550 ³⁾
Distance from arm support to seat [mm]	245	340
Angle from leg support to seat bottom [°]	Angle-adjustable (as needed)	
Handrim diameter [mm]	470	560
Minimum turning radius [mm] ¹⁾	550	740

¹⁾ In accordance with ISO 7176-5.

²⁾ The specified weights vary according to the selected options and model.

3) Restriction due to normative ground clearance requirements; individually larger by customer request, maximum depending on seat height, foot plate and foot plate angle setting.

Ambient conditions

Temperatures and relative humidity	
Temperature during use [°C (°F)]	-10 to +40 (14 to 104)
Transport and storage temperature [°C (°F)]	-10 to +40 (14 to 104)
Relative humidity [%]	45 to 85; non-condensing

12 Appendices

12.1 Threshold values for wheelchairs transportable by train

INFORMATION

► The products in this series fully satisfy the minimum technical requirements of regulation (EU) No. 1300/2014 regarding train accessibility for people with disabilities.

Feature	Threshold value (according to Directive (EU) No. 1300/2014)
Length [mm]	1200 (plus 50 mm for the feet)
Width [mm]	700 (plus 50 mm on each side for the hands when moving)
Smallest wheels ["]	approx. 3 or greater (according to the directive, the smallest wheel must be able to overcome a gap measuring 75 mm horizontally and 50 mm vertically)
Height [mm]	max. 1375; including a 1.84 m large male wheelchair user (95th percentile)
Turning radius [mm]	1500
Maximum weight [kg]	200 (for wheelchair and user, including any baggage)
Maximum obstacle height that can be overcome [mm]	50
Ground clearance [mm]	60 (at an upward slope angle of 10°, ground clearance must measure at least 60 mm under the footrest for going forward at the end of the slope)
Maximum inclination angle on which the wheelchair will remain stable [°]	6 (dynamic stability in all directions) 9 (static stability in all directions, also when wheel lock engaged)



A series of horizontal lines for writing, spanning the width of the page.

Kundenservice/Customer Service

Europe

Otto Bock HealthCare Deutschland GmbH
Max-Näder-Str. 15 · 37115 Duderstadt · Germany
T +49 5527 848-3433 · F +49 5527 848-1460
healthcare@ottobock.de · www.ottobock.de

Otto Bock Healthcare Products GmbH
Brehmstraße 16 · 1110 Wien · Austria
F +43 1 5267985
service-admin.vienna@ottobock.com · www.ottobock.at

Otto Bock Adria d.o.o. Sarajevo
Ramiza Salčina 85
71000 Sarajevo · Bosnia-Herzegovina
T +387 33 255-405 · F +387 33 255-401
obadria@bih.net.ba · www.ottobockadria.com.ba

Otto Bock Bulgaria Ltd.
41 Tzar Boris IIIrd Blvd. · 1612 Sofia · Bulgaria
T +359 2 80 57 980 · F +359 2 80 57 982
info@ottobock.bg · www.ottobock.bg

Otto Bock Suisse AG
Luzerner Kantonsspital 10 · 6000 Luzern 16 · Suisse
T +41 41 455 61 71 · F +41 41 455 61 70
suisse@ottobock.com · www.ottobock.ch

Otto Bock ČR s.r.o.
Protetická 460 · 33008 Zruč-Senec · Czech Republic
T +420 377825044 · F +420 377825036
email@ottobock.cz · www.ottobock.cz

Otto Bock Iberica S.A.
C/Majada, 1 · 28760 Tres Cantos (Madrid) · Spain
T +34 91 8063000 · F +34 91 8060415
info@ottobock.es · www.ottobock.es

Otto Bock France SNC
4 rue de la Réunion · CS 90011
91978 Courtaboeuf Cedex · France
T +33 1 69188830 · F +33 1 69071802
information@ottobock.fr · www.ottobock.fr

Otto Bock Healthcare plc
32, Parsonage Road · Englefield Green
Egham, Surrey TW20 0LD · United Kingdom
T +44 1784 744900 · F +44 1784 744901
bockuk@ottobock.com · www.ottobock.co.uk

Otto Bock Hungária Kft.
Tatai út 74. · 1135 Budapest · Hungary
T +36 1 4511020 · F +36 1 4511021
info@ottobock.hu · www.ottobock.hu

Otto Bock Adria d.o.o.
Dr. Franje Tuđmana 14 · 10431 Sveta Nedelja · Croatia
T +385 1 3361 544 · F +385 1 3365 986
ottobockadria@ottobock.hr · www.ottobock.hr

Otto Bock Italia Srl Us
Via Filippo Turati 5/7 · 40054 Budrio (BO) · Italy
T +39 051 692-4711 · F +39 051 692-4720
info.italia@ottobock.com · www.ottobock.it

Otto Bock Benelux B.V.
Mandenmaker 14 · 5253 RC
Nieuwkuijk · The Netherlands
T +31 73 5186488 · F +31 73 5114960
info.benelux@ottobock.com · www.ottobock.nl

Industria Ortopédica Otto Bock Unip. Ltda.
Av. Miguel Bombarda, 21 - 2º Esq.
1050-161 Lisboa · Portugal
T +351 21 3535587 · F +351 21 3535590
ottobockportugal@mail.telepac.pt

Otto Bock Polska Sp. z o. o.
Ulica Koralowa 3 · 61-029 Poznań · Poland
T +48 61 6538250 · F +48 61 6538031
ottobock@ottobock.pl · www.ottobock.pl

Otto Bock Romania srl
Șos de Centura Chitila - Mogoșoia Nr. 3
077405 Chitila, Jud. Ilfov · Romania
T +40 21 4363110 · F +40 21 4363023
info@ottobock.ro · www.ottobock.ro

OOO Otto Bock Service
p/o Pultikovo, Business Park „Greenwood”,
Building 7, 69 km MKAD
143441 Moscow Region/Krasnogorskiy Rayon
Russian Federation
T +7 495 564 8360 · F +7 495 564 8363
info@ottobock.ru · www.ottobock.ru

Otto Bock Scandinavia AB
Koppargatan 3 · Box 623 · 60114 Norrköping · Sweden
T +46 11 280600 · F +46 11 312005
info@ottobock.se · www.ottobock.se

Otto Bock Slovakia s.r.o.
Röntgenova 26 · 851 01 Bratislava 5 · Slovak Republic
T +421 2 32 78 20 70 · F +421 2 32 78 20 89
info@ottobock.sk · www.ottobock.sk

Otto Bock Sava d.o.o.
Industrijska bb · 34000 Kragujevac · Republika Srbija
T +381 34 351 671 · F +381 34 351 671
info@ottobock.rs · www.ottobock.rs

Otto Bock Ortopedi ve
Rehabilitasyon Tekniği Ltd. Şti.
Mecidiyeköy Mah. Lati Lokum Sok.
Meriç Sitesi B Blok No: 30/B
34387 Mecidiyeköy-Istanbul · Turkey
T +90 212 3565040 · F +90 212 3566688
info@ottobock.com.tr · www.ottobock.com.tr

Africa

Otto Bock Algérie E.U.R.L.
32, rue Ahcène Outaleb - Coopérative les Mimosas
Mackle-Ben Aknoun · Alger · DZ Algérie
T +213 21 913863 · F +213 21 913863
information@ottobock.fr · www.ottobock.fr

Otto Bock Egypt S.A.E.
28 Soliman Abaza St. Mohandessein · Giza · Egypt
T +20 2 37606818 · F +20 2 37605734
info@ottobock.com.eg · www.ottobock.com.eg

Otto Bock South Africa (Pty) Ltd
Building 3 Thornhill Office Park · 94 Bekker Road
Midrand · Johannesburg · South Africa
T +27 11 564 9360
info-southafrica@ottobock.co.za
www.ottobock.co.za

Americas

Otto Bock Argentina S.A.
Av. Belgrano 1477 · CP 1093
Ciudad Autónoma de Buenos Aires · Argentina
T +54 11 5032-8201 / 5032-8202
atencionclientes@ottobock.com.ar
www.ottobock.com.ar

Otto Bock do Brasil Tecnica Ortopédica Ltda.
Alameda Maria Tereza, 4036, Bairro Dois Córregos
CEP: 13.278-181, Valinhos-São Paulo · Brasil
T +55 19 3729 3500 · F +55 19 3269 6061
ottobock@ottobock.com.br · www.ottobock.com.br

Otto Bock HealthCare Canada
5470 Harvester Road
Burlington, Ontario, L7L 5N5, Canada
T +1 800 665 3327 · F +1 800 463 3659
CACustomerService@ottobock.com
www.ottobock.ca

Oficina Ottobock Habana
Calle 3ra entre 78 y 80.
Edificio Jerusalem · Oficina 112 · Calle 3ra.
Playa, La Habana. Cuba
T +53 720 430 69 · +53 720 430 81
hector.corcho@ottobock.com.br
www.ottobock.com.br

Otto Bock HealthCare Andina Ltda.
Calle 138 No 53-38 · Bogotá · Colombia
T +57 1 8619988 · F +57 1 8619977
info@ottobock.com.co · www.ottobock.com.co

Otto Bock de Mexico S.A. de C.V.
Prolongación Calle 18 No. 178-A
Col. San Pedro de los Pinos
C.P. 01180 México, D.F. · Mexico
T +52 55 5575 0290 · F +52 55 5575 0234
info@ottobock.com.mx · www.ottobock.com.mx

Otto Bock HealthCare LP
11501 Alterra Parkway Suite 600
Austin, TX 78758 · USA
T +1 800 328 4058 · F +1 800 962 2549
USCustomerService@ottobock.com
www.ottobockus.com

Asia/Pacific

Otto Bock Australia Pty. Ltd.
Suite 1.01, Century Corporate Centre
62 Norwest Boulevard
Baulkham Hills NSW 2153 · Australia
T +61 2 8818 2800 · F +61 2 8814 4500
healthcare@ottobock.com.au · www.ottobock.com.au

Beijing Otto Bock Orthopaedic Industries Co., Ltd.
B12E, Universal Business Park
10 Jiuxianqiao Road, Chao Yang District
Beijing, 100015, P.R. China
T +8610 8598 6880 · F +8610 8598 0040
news-service@ottobock.com.cn
www.ottobock.com.cn

Otto Bock Asia Pacific Ltd.
Unit 1004, 10/F, Greenfield Tower, Concordia Plaza
1 Science Museum Road, Tsim Sha Tsui
Kowloon, Hong Kong · China
T +852 2598 9772 · F +852 2598 7886
info@ottobock.com.hk · www.ottobock.com

Otto Bock HealthCare India Pvt. Ltd.
20th Floor, Express Towers
Nariman Point, Mumbai 400 021 · India
T +91 22 2274 5500 / 5501 / 5502
information@indiaottobock.com · www.ottobock.in

Otto Bock Japan K. K.
Yokogawa Building 8F, 4-4-44 Shibaura
Minato-ku, Tokyo, 108-0023 · Japan
T +81 3 3798-2111 · F +81 3 3798-2112
ottobock@ottobock.co.jp · www.ottobock.co.jp

Otto Bock Korea HealthCare Inc.
4F Agaworld Building · 1357-74, Seocho-dong
Seocho-ku, 137-070 Seoul · Korea
T +82 2 577-3831 · F +82 2 577-3828
info@ottobockkorea.com · www.ottobockkorea.com

Otto Bock South East Asia Co., Ltd.
1741 Phaholyothin Road
Kwaeng Chatuchark · Khet Chatuchark
Bangkok 10900 · Thailand
T +66 2 930 3030 · F +66 2 930 3311
obsea@ottobock.co.th · www.ottobock.co.th

Other countries

Ottobock SE & Co. KGaA
Max-Näder-Straße 15 · 37115 Duderstadt · Germany
T +49 5527 848-1590 · F +49 5527 848-1676
reha-export@ottobock.de · www.ottobock.com

Ihr Fachhändler | Your specialist dealer



Otto Bock Mobility Solutions GmbH
Lindenstraße 13 · 07426 Königsee/Germany
www.ottobock.com

